

Ophthalmic Knife and Surgical Disposable Catalog



The entire Accutome team extends our appreciation for all of your support throughout the years. As we embark on our fourth decade in the industry, the three major traits that keep the Accutome brand growing remain the same: Superior Customer Service, Quality and Innovation. It is our goal to make every experience you have with us special and productive.

Our focus is to continue to improve our product line and customer service to better suit your needs. This year, we have added more customer service representatives and sales representatives to provide worldwide support. We also have a European office in the Netherlands.

We have become a great resource for all of your surgical and diagnostic needs. This surgical catalog is a useful tool to improve your Accutome experience. We carry thousands of products. If you do not see a product, give our representatives a call and we will find it for you.

We look forward to continuing to supply your office and surgery center with the finest products and superior customer service.



DIAMOND KNIVES	1
Phaco Incision Diamond Knives.....	1
Specialty Diamond Knives.....	3
Paracentesis/Stab Diamond Knives.....	3
Astigmatism Management Diamond Knives	4
ACCUSHARPS	5
Disposable Ophthalmic Knives	5
SAPPHIRE KNIVES	7
Sapphire Knives.....	7
SUTURES	8
Nylon, Black Mono.....	8
Polyester	11
Silk.....	12
Polyglycolic Acid.....	14
ACCU-SURGICAL DISPOSABLE CANNULAS	16
Retrobulbars and Peribulbars.....	16
Anterior Chamber Cannulas.....	18
Anterior Chamber Cannulas, Thin Wall	20
I/A Cannulas and Cortex Removal	20
Button Coaxial I/A System	21
“J” Shaped Cannulas.....	22
Cystotomes	23
Capsule Polishers	24
Nucleus Removal, Irrigating, Hydrodissection and Hydrodelineation	25
Miscellaneous Instruments.....	27
Chamber Maintainers and Retinal Cannulas	31
Lasik Cannulas.....	34
Femtosecond Cannulas	34
Dropless Cataract Surgery Cannula	34
DISPOSABLE I/A INSTRUMENTS	35
Bi-Manual I/A Systems	35
Mono-Manual I/A Systems.....	35
VACUUM TREPHINES AND PUNCHES	37
Radial Vacuum Trephines.....	37
Vacuum Donor Punches.....	38
SPECIALTY SURGICAL PRODUCTS	39
Surgical Disposables.....	39
Cleaners and Sterilizers.....	40



PHACO INCISION DIAMOND KNIVES

Angled holder unless specified.

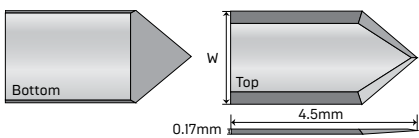

SIMPLICITY

The Simplicity Series is the perfect blend of design and craftsmanship helping make superior corneal incisions. The blade features a unique top and bottom bevel design which creates a self-sealing incision with a single pass. This linear incision is created without having to applanate or "dimple down".

Item #	Description
AK6419	2.2mm
AK6424	2.4mm
AK6415	2.5mm
AK6410	2.65mm

Item #	Description
AK6427	2.75mm
AK6411	2.8mm
AK6412	3.0mm
AK6413	3.2mm

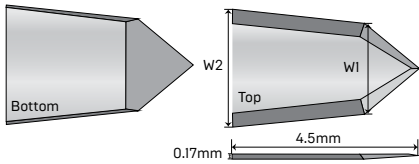

SIMPLICITY TRAPEZOID

Item #	Width 1 (W1)	Width 2 (W2)
AK6449	2.2mm	2.4mm
AK6450	2.5mm	2.8mm
AK6459	2.5mm	2.9mm
AK6461	2.5mm	3.0mm
AK6465	2.5mm	3.5mm
AK6451	2.65mm	3.0mm

Item #	Width 1 (W1)	Width 2 (W2)
AK6452	2.7mm	3.2mm
AK6453	2.8mm	3.0mm
AK6458	2.8mm	3.2mm
AK6454	3.0mm	3.2mm
AK6455	3.0mm	3.5mm
AK6456	3.2mm	3.5mm

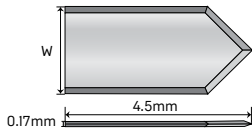

DUAL BEVEL (4-SIDES SHARP)

Item #	Width
AK6017	1.65mm
AK6021	1.8mm
AK6022	2.0mm
AK6019	2.2mm
AK6024	2.4mm

Item #	Width
AK6015	2.5mm
AK6010	2.65mm
AK6011	2.8mm
AK6012	3.0mm
AK6013	3.2mm

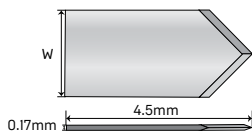

DUAL BEVEL (DULL SIDES)

Item #	Width
AK6007	1.65mm
AK6009	2.2mm
AK6023	2.4mm
AK6005	2.5mm

Item #	Width
AK6000	2.65mm
AK6001	2.8mm
AK6002	3.0mm
AK6003	3.2mm

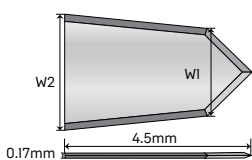

CLEAR CORNEA TRAPEZOID

Item #	Width 1 (W1)	Width 2 (W2)
AK6047	1.2mm	1.4mm
AK6072	2.0mm	2.2mm
AK6070	2.2mm	2.5mm
AK6050	2.5mm	2.8mm
AK6059	2.5mm	2.9mm
AK6064	2.5mm	3.0mm
AK6060	2.5mm	3.2mm

Item #	Width 1 (W1)	Width 2 (W2)
AK6065	2.5mm	3.5mm
AK6051	2.65mm	3.0mm
AK6052	2.7mm	3.2mm
AK6053	2.8mm	3.0mm
AK6058	2.8mm	3.2mm
AK6067	2.8mm	3.5mm
AK6054	3.0mm	3.2mm

SPECIALTY DIAMOND KNIVES

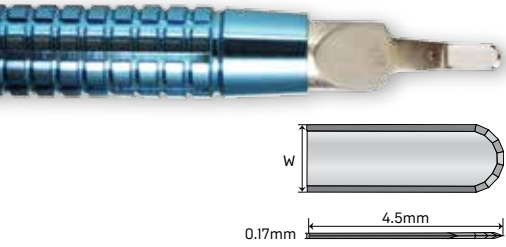

CRESCENT

Item #	Description
AK6044	1.0mm angled
AK6040	1.4mm angled
AK6041	2.0mm angled

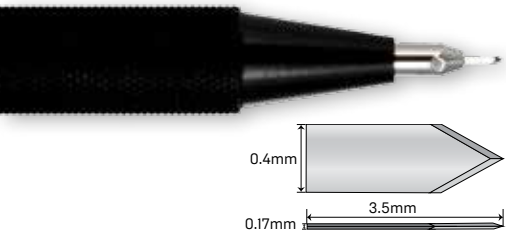

SCLEROSTOMY

Item #	Description
AK6180	0.4mm x 3.5mm lancet straight holder

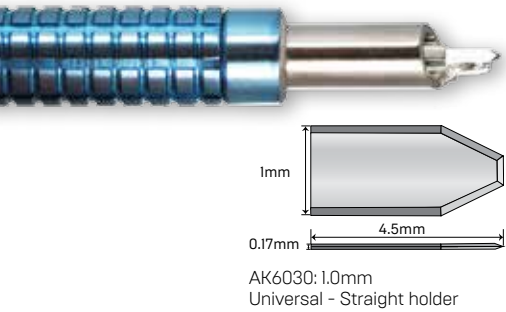

UNIVERSAL CATARACT KNIFE

Straight step handle with 0.3 mm, 0.6mm, and full extension for increased versatility.

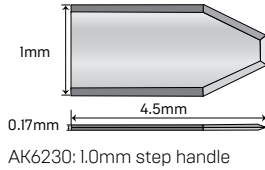
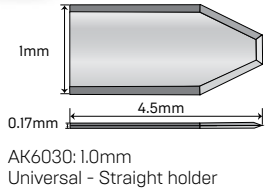

PARACENTESIS/ STAB DIAMOND KNIVES

Straight holder unless specified. Customized preset available.

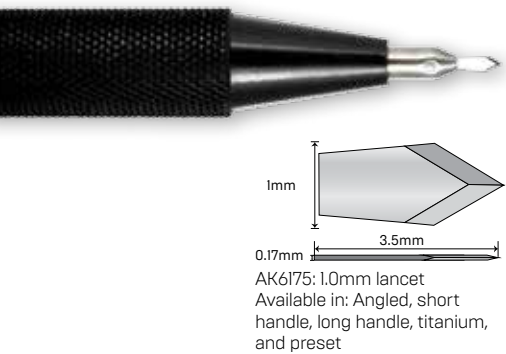

HAWKEYE SERIES

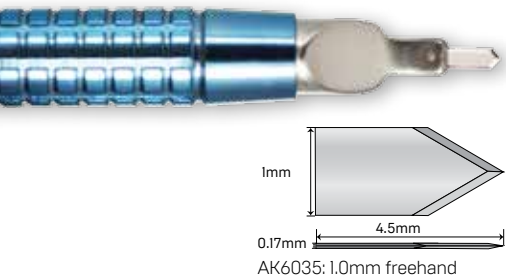
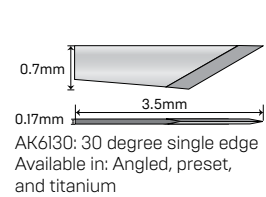
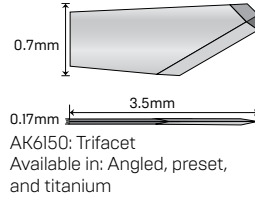
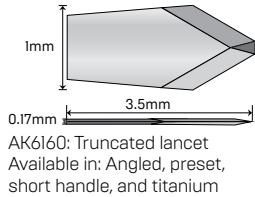
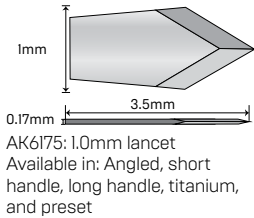

HAWKEYE PREMIUM SERIES

Also available in a step handle.

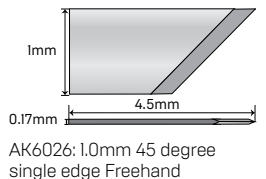
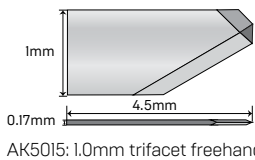
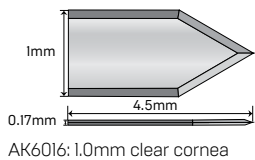
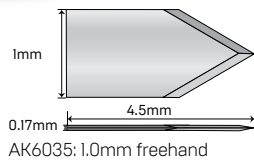

ASTIGMATISM MANAGEMENT DIAMOND KNIVES

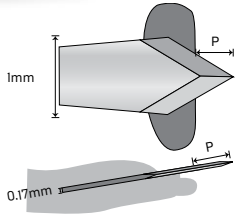

DONNENFELD PRESET LRI

15 degree angled footplate.

Item #	Description	Item #	Description
AK6175SPT	Short handle - 2.625" handle length	AK6160SPT	Truncated lancet, preset, short handle
AK6175PT	Long handle - 4.5" handle length	AK6160PT	Truncated lancet, long handle

P= Choice of 0.5mm, 0.55mm, or 0.6mm depth.

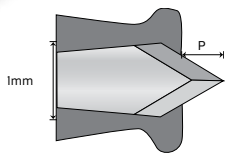

RUBENSTEIN/CHANG PRESET LRI

Item #	Description
AK6175P	Rubenstein LRI knife - 4.75" handle length (black handle)
AK6175PC	Chang LRI knife - 3.5" handle length (gold handle)

P= Choice of 0.5mm, 0.55mm, or 0.6mm depth.

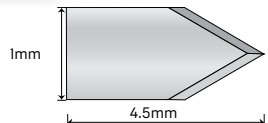

AK6235: 1.0mm lancet dull sides, step handle

SURGEON'S CHOICE ADJUSTABLE PRESET KNIVES

0.5mm, 0.55mm, 0.6mm and full extension.

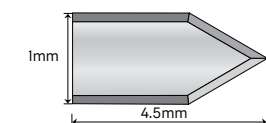

AK6216: 1.0mm clear cornea step handle

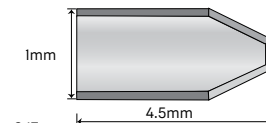

AK6230: 1.0mm step handle

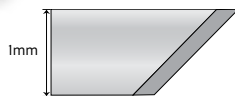

AK5002: Single edge 45 degree RK

MICROMETER

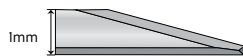

AK5003: 15 degree arcuate AK. Available in: Preset



AK5004: Tri-Square (Triple 90)
AK Available in: 1mm, 0.6mm, 0.75mm

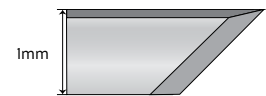

AK5005: 45 degree double edge RK. Available in: Preset

AccuSharp
Non-Guarded Knives



AccuSharp
Guarded Knives





DISPOSABLE OPHTHALMIC KNIVES

AccuSharps are packaged 6 per box. Knives marked "Guarded Blade" are available with a smooth, single handed blade retraction feature.

STRAIGHT KNIVES

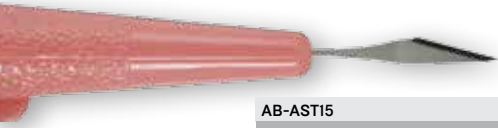

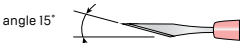
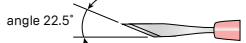





Double Bevel 

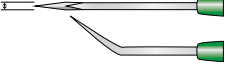
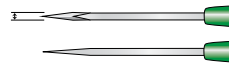

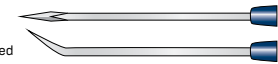
AB-AST15 AB-AST15G Guarded Blade  angle 15°	AB-AST22 AB-AST22G Guarded Blade  angle 22.5°	AB-AST30  angle 30°	AB-AST45  angle 45°
----------------------------------------------------------------------------------------------------------------------------------------------------	------------------------------------------------------------------------------------------------------------------------------------------------------	-------------------------------------------------------------------------------------------------------------------	--------------------------------------------------------------------------------------------------------------------

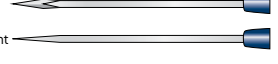
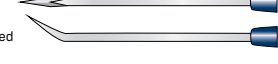
SIDEPORT/ MVR KNIVES



AB-AVR10 1.0mm Angled 	AB-AVR10S 1.0mm Straight 	AB-AVR19 19 Gauge AB-AVR19G Guarded Blade Straight 	AB-AVR19AG Guarded Blade 19G Angled 
AB-AVR20 20 Gauge AB-AVR20G Guarded Blade Straight 	AB-AVR20A 20 Gauge AB-AVR20AG Guarded Blade Angled 	AB-AVR21G Guarded Blade 21G Straight 	AB-AVR21AG Guarded Blade 21G Angled 
AB-AVR23G Guarded Blade 23G Straight 	AB-AVR23A 23 Gauge AB-AVR23AG Guarded Blade Angled 	AB-AVR25G Guarded Blade 25G Straight 	AB-AVR25AG Guarded Blade 25G Angled 



ANGLED SLIT KNIVES

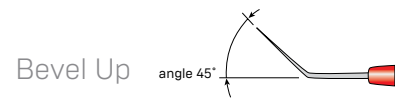

AB-ASL10	AB-ASL12	AB-ASL14	AB-ASL16
1.0mm	1.2mm	1.4mm	1.6mm
AB-ASL18	AB-ASL20	AB-ASL22 AB-ASL22G Guarded Blade	AB-ASL22NC Double Bevel
1.8mm	2.0mm	2.2mm	2.2mm
AB-ASL23	AB-ASL24 AB-ASL24G Guarded Blade	AB-ASL25 AB-ASL25G Guarded Blade	AB-ASL26 AB-ASL26G Guarded Blade
2.3mm	2.4mm	2.5mm	2.65mm
AB-ASL27 AB-ASL27G Guarded Blade	AB-ASL28 AB-ASL28G Guarded Blade	AB-ASL285	AB-ASL30 AB-ASL30G Guarded Blade
2.75mm	2.8mm	2.85mm	3.0mm
AB-ASL32 AB-ASL32G Guarded Blade	AB-ASL35		
3.2mm	3.5mm		



STRAIGHT SLIT KNIVES

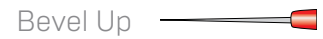

AB-ASL285S	AB-ASL30S
2.85mm	3.0mm



CRESCENT KNIVES

AB-ACS20 Bevel Up	AB-ACD26 Bevel Down	AB-ACU26 Bevel Up AB-ACU26G Guarded Blade
2.0mm	2.0mm	2.0mm
Straight	angle 45°	angle 45°



ANGLED IMPLANT KNIVES

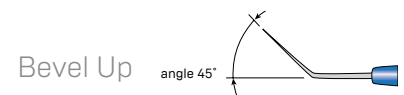

AB-ARS32	AB-ARS35	AB-ARS41	AB-ARS52
3.2mm	3.5mm	4.1mm	5.2mm

SAPPHIRE KNIVES

All sapphire knives come in an alluminum J-Locking handle. Other sizes are available upon request. Please call for more information.

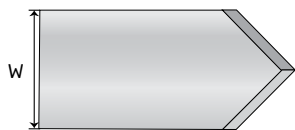

Angled Holder

SPEAR

Item #	Description
AK0001L	2.8mm
AK0002L	3.0mm

Item #	Description
AK0003L	3.2mm

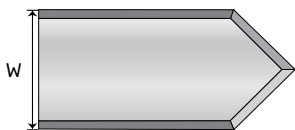

Angled Holder

CLEAR CORNEA

Item #	Description
AK0018L	1.5mm
AK0019	2.2mm
AK0011L	2.8mm

Item #	Description
AK0012L	3.0mm
AK0013L	3.2mm

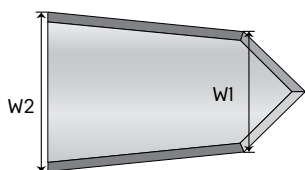

Angled Holder

TRAPEZOID

Item #	Width 1 (W1)	Width 2 (W2)
AK0038	0.9mm	1.2mm
AK0025	2.2mm	2.5mm

Item #	Width 1 (W1)	Width 2 (W2)
AK0061	2.5mm	3.0mm
AK0060	2.5mm	3.2mm

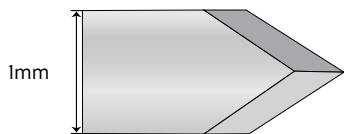

Straight Holder

LANCET

Item #	Description
AK0035	1.0mm

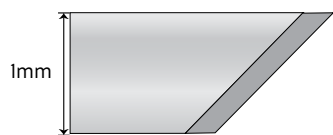

Straight Holder

SINGLE EDGE

Item #	Description
AK0002	1.0mm 45 Degree

Item #	Description
AK0009	1.0mm 30 Degree

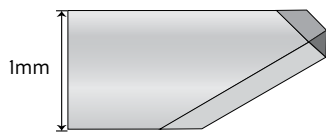

Straight Holder

TRI-FACET

Item #	Description
AK0010	1.0mm

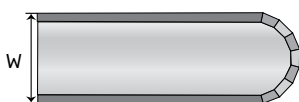



Angled Holder

CRESCENT

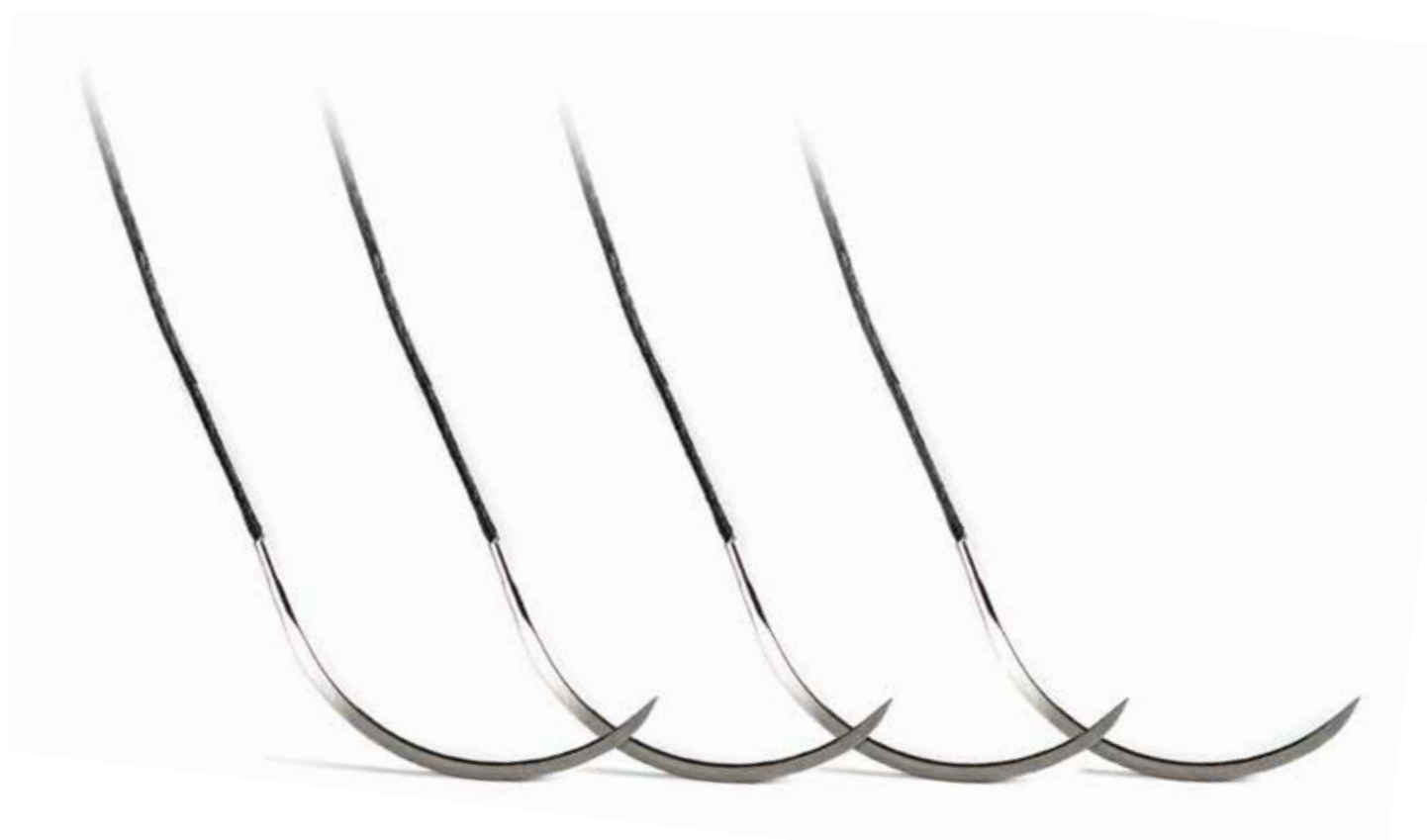











Item #	Description
AK0041	2.0mm











NYLON, BLACK MONO

Sold 12 per box.  Represents a single arm suture.  Represents a double arm suture.



11-0 (0.1 METRIC)

Item #	Image	Edgemark	Curve	Needle Length	Diameter	Material Length
AB-0550S		Taper Point 	3/8	4.0mm	0.05mm	13cm
AB-1478S		Trape Spatula 	3/8	6.0mm	0.14mm	15cm
AB-1403		Trape Spatula 	7/16	5.5mm	0.14mm	20cm
AB-1476		Trape Spatula 	7/16	5.5mm	0.14mm	30cm
AB-1000		Trape Spatula 	7/16	5.5mm	0.10mm	20cm
AB-1000S		Trape Spatula 	7/16	5.5mm	0.10mm	10cm

































10-0 (0.2 METRIC)

Item #	Image	Edgemark	Curve	Needle Length	Diameter	Material Length
AB-1474		Trape Spatula 	Bi-curve	5.0mm	0.14mm	20cm
AB-1401		Trape Spatula 	Bi-curve	5.0mm	0.14mm	30cm
AB-1401S		Trape Spatula 	Bi-curve	5.0mm	0.14mm	15cm
AB-1406		Trape Spatula 	3/8	6.0mm	0.14mm	30cm













NYLON, BLACK MONO [continued]

Sold 12 per box.  Represents a single arm suture.  Represents a double arm suture.







10-0 (0.2 METRIC) [continued]

Item #	Image	Edgemark	Curve	Needle Length	Diameter	Material Length
AB-I406S		Trape Spatula 	3/8	6.0mm	0.14mm	15cm
AB-I468S		Trape Spatula 	3/8	6.0mm	0.14mm	6cm
AB-I452		Trape Spatula 	3/8	6.0mm	0.14mm	15cm
AB-2002		Trape Spatula 	3/8	6.5mm	0.20mm	30cm
AB-2002S		Trape Spatula 	3/8	6.5mm	0.20mm	15cm
AB-I053S		Taper Point 	3/8	4.0mm	0.10mm	20cm
AB-I052S		Taper Point 	3/8	5.0mm	0.10mm	20cm
AB-I459		Taper Point 	3/8	6.0mm	0.14mm	45cm
AB-I001		Trape Spatula 	7/16	5.5mm	0.10mm	30cm
AB-I404		Trape Spatula 	7/16	5.5mm	0.14mm	30cm
AB-I404S		Trape Spatula 	7/16	5.5mm	0.14mm	15cm
AB-I482		Trape Spatula 	7/16	5.5mm	0.14mm	15cm
AB-2000		Trape Spatula 	7/16	5.5mm	0.20mm	30cm
AB-I475		Taper Point 	7/16	5.5mm	0.14mm	30cm
AB-I410		Trape Spatula 	1/2	7.0mm	0.14mm	30cm
AB-I410S		Trape Spatula 	1/2	7.0mm	0.14mm	15cm



9-0 (0.3 METRIC)

Item #	Image	Edgemark	Curve	Needle Length	Diameter	Material Length
AB-I402		Trape Spatula 	Bi-curve	5.0mm	0.14mm	30cm
AB-I407		Trape Spatula 	3/8	6.0mm	0.14mm	30cm
AB-I407S		Trape Spatula 	3/8	6.0mm	0.14mm	15cm
AB-2003		Trape Spatula 	3/8	6.5mm	0.20mm	30cm
AB-2003S		Trape Spatula 	3/8	6.5mm	0.20mm	15cm
AB-I405		Trape Spatula 	7/16	5.5mm	0.14mm	30cm



8-0 (0.4 METRIC)

Item #	Image	Edgemark	Curve	Needle Length	Diameter	Material Length
AB-2054		Trape Spatula 	1/4	6.5mm	0.20mm	30cm
AB-2056		Trape Spatula 	3/8	6.5mm	0.20mm	30cm
AB-2461		Reverse Cut 	3/8	11.0mm	0.24mm	50cm











NYLON, BLACK MONO [continued]

Sold 12 per box.  Represents a single arm suture.  Represents a double arm suture.









8-0 (0.4 METRIC) [continued]

Item #	Image	Edgemark	Curve	Needle Length	Diameter	Material Length
AB-2461S		Reverse Cut ▼	3/8	11.0mm	0.24mm	50cm
AB-1421		Trape Spatula ▼	7/16	5.5mm	0.14mm	30cm
AB-2028		Trape Spatula ▼	1/2	7.0mm	0.20mm	30cm

7-0 (0.5 METRIC)



Item #	Image	Edgemark	Curve	Needle Length	Diameter	Material Length
AB-2058		Trape Spatula ▼	3/8	6.5mm	0.20mm	30cm
AB-2855		Trape Spatula ▼	3/8	8.0mm	0.28mm	45cm
AB-2455S		Reverse Cut ▼	3/8	7.0mm	0.24mm	45cm
AB-2457S		Reverse Cut ▼	3/8	9.0mm	0.24mm	50cm
AB-2463		Reverse Cut ▼	3/8	11.0mm	0.24mm	30cm
AB-3361		Lancet ▼	3/8	8.0mm	0.33mm	30cm
AB-3361S		Lancet ▼	3/8	8.0mm	0.33mm	45cm
AB-3364		Lancet ▼	3/8	11.0mm	0.33mm	50cm
AB-3364S		Lancet ▼	3/8	11.0mm	0.33mm	50cm
AB-3365		Cut Taper (Y)	3/8	15.0mm	0.33mm	30cm
AB-1457		Trape Spatula ▼	7/16	5.5mm	0.14mm	30cm

6-0 (0.7 METRIC)







Item #	Image	Edgemark	Curve	Needle Length	Diameter	Material Length
AB-2854		Trape Spatula ▼	3/8	8.0mm	0.28mm	45cm
AB-2808		Reverse Cut ▼	3/8	13.0mm	0.28mm	30cm
AB-2808S		Reverse Cut ▼	3/8	13.0mm	0.28mm	20cm
AB-3379S		Lancet ▼	3/8	7.0mm	0.33mm	30cm
AB-3382		Lancet ▼	3/8	11.0mm	0.33mm	50cm
AB-3382S		Lancet ▼	3/8	11.0mm	0.33mm	45cm
AB-3853S		Lancet ▼	3/8	11.0mm	0.38mm	45cm
AB-3386		Cut Taper (Y)	3/8	15.0mm	0.33mm	30cm
AB-2859		Trape Spatula ▼	7/16	8.0mm	0.28mm	45cm

SUTURES



NYLON, BLACK MONO [continued]

Sold 12 per box.  Represents a single arm suture.  Represents a double arm suture.







6-0 (0.7 METRIC) [continued]

Item #	Image	Edgemark	Curve	Needle Length	Diameter	Material Length
AB-3362S		Lancet 	1/2	8.0mm	0.33mm	50cm
AB-3381S		Lancet 	1/2	11.0mm	0.33mm	45cm
AB-3363S		Lancet 	1/2	13.0mm	0.33mm	45cm

POLYESTER













Sold 12 per box.  Represents a single arm suture.  Represents a double arm suture.

10-0 (0.2 METRIC)

Item #	Image	Edgemark	Curve	Needle Length	Diameter	Material Length
AB-1412		Trape Spatula 	3/8	6.0mm	0.14mm	30cm
AB-2017		Trape Spatula 	3/8	6.5mm	0.20mm	30cm
AB-1411		Trape Spatula 	7/16	5.5mm	0.14mm	30cm



Green Mono

5-0 (1.0 METRIC)











Item #	Image	Edgemark	Curve	Needle Length	Diameter	Material Length
AB-3377		Trape Spatula 	1/4	8.0mm	0.33mm	45cm
AB-2863		Dia Spatula 	1/4	6.0mm	0.28mm	45cm
AB-3372		Dia Spatula 	1/4	6.0mm	0.33mm	45cm
AB-3370		Dia Spatula 	1/4	8.0mm	0.33mm	45cm
AB-3380		Taper Point 	3/8	10.0mm	0.33mm	45cm
AB-3371		Dia Spatula 	1/2	8.0mm	0.33mm	45cm

White Braided











POLYESTER (continued)

Sold 12 per box.  Represents a single arm suture.  Represents a double arm suture.

5-0 (1.0 METRIC) (continued)

	Item #	Image	Edgemark	Curve	Needle Length	Diameter	Material Length
Green Braided	AB-3376		Trape Spatula 	1/4	8.0mm	0.33mm	45cm
	AB-3375		Dia Spatula 	1/4	6.0mm	0.33mm	45cm
	AB-3373		Dia Spatula 	1/4	8.0mm	0.33mm	45cm
	AB-3374		Dia Spatula 	1/4	8.0mm	0.33mm	45cm
	AB-3378		Taper Point 	3/8	10.0mm	0.33mm	75cm







4-0 (1.5 METRIC)

	Item #	Image	Edgemark	Curve	Needle Length	Diameter	Material Length
White Braided	AB-4356		Trape Spatula 	1/4	8.0mm	0.43mm	45cm
	AB-4357		Dia Spatula 	1/4	6.5mm	0.43mm	45cm
	AB-4352		Dia Spatula 	1/4	8.0mm	0.43mm	45cm
Green Braided	AB-4355		Trape Spatula 	1/4	8.0mm	0.43mm	45cm
	AB-4353		Dia Spatula 	1/4	8.0mm	0.43mm	45cm











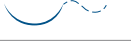

SILK

Sold 12 per box.  Represents a single arm suture.  Represents a double arm suture.



8-0 (0.4 METRIC)

	Item #	Image	Edgemark	Curve	Needle Length	Diameter	Material Length
Black Braided	AB-1467		Trape Spatula 	3/8	6.0mm	0.18mm	45cm
	AB-2023		Trape Spatula 	3/8	6.5mm	0.20mm	45cm
	AB-2023S		Trape Spatula 	3/8	6.5mm	0.20mm	20cm











7-0 (0.5 METRIC)

	Item #	Image	Edgemark	Curve	Needle Length	Diameter	Material Length
Black Braided	AB-2008		Trape Spatula 	3/8	6.5mm	0.20mm	45cm
	AB-2063		Trape Spatula 	3/8	6.5mm	0.20mm	30cm
	AB-2008S		Trape Spatula 	3/8	6.5mm	0.20mm	30cm
	AB-2860S		Lancet 	3/8	7.0mm	0.28mm	50cm
	AB-2062S		Trape Spatula 	1/2	8.0mm	0.20mm	45cm
White Braided	AB-2068S		Trape Spatula 	1/2	8.0mm	0.20mm	45cm

SILK (continued)









Sold 12 per box.  Represents a single arm suture.  Represents a double arm suture.

6-0 (0.7 METRIC) (continued)

Item #	Image	Edgemark	Curve	Needle Length	Diameter	Material Length
AB-2805		Reverse Cut ▼	5/16	8.0mm	0.28mm	45cm
AB-2801		Trape Spatula ▼	3/8	6.5mm	0.28mm	45cm
AB-3354S		Trape Spatula ▼	3/8	10.0mm	0.33mm	50cm
AB-2853		Reverse Cut ▼	3/8	7.0mm	0.28mm	45cm
AB-3305		Reverse Cut ▼	3/8	11.0mm	0.33mm	45cm
AB-3305S		Reverse Cut ▼	3/8	11.0mm	0.33mm	45cm
AB-3366		Lancet ▼	3/8	10.0mm	0.33mm	55cm
AB-3356		Taper Point ○	3/8	13.0mm	0.33mm	55cm
AB-3353		Cut Taper ○	3/8	13.0mm	0.33mm	55cm
AB-3850S		Cut Taper ○	3/8	14.0mm	0.38mm	60cm
AB-2804		Trape Spatula ▼	7/16	5.5mm	0.28mm	45cm



Black Braided

5-0 (1.0 METRIC)









Item #	Image	Edgemark	Curve	Needle Length	Diameter	Material Length
AB-4350S		Reverse Cut ▼	3/8	11.0mm	0.43mm	50cm
AB-3358S		Reverse Cut ▼	3/8	13.0mm	0.33mm	50cm
AB-3856		Lancet ▼	3/8	11.0mm	0.38mm	50cm
AB-3856S		Lancet ▼	3/8	11.0mm	0.38mm	50cm
AB-3355		Taper Point ○	3/8	13.0mm	0.33mm	45cm
AB-3355S		Taper Point ○	3/8	13.0mm	0.33mm	30cm
AB-3855		Taper Point ○	3/8	16.0mm	0.38mm	60cm
AB-3855S		Taper Point ○	3/8	16.0mm	0.38mm	30cm

Black Braided

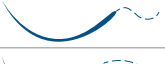
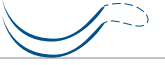
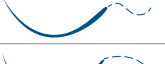
SILK (continued)

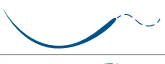
Sold 12 per box.  Represents a single arm suture.  Represents a double arm suture.

4-0 (1.5 METRIC)

Item #	Image	Edgemark	Curve	Needle Length	Diameter	Material Length
AB-4351		Reverse Cut ▼	3/8	13.0mm	0.43mm	50cm
AB-4351S		Reverse Cut ▼	3/8	13.0mm	0.43mm	50cm
AB-4359		Lancet ▽	3/8	13.0mm	0.43mm	55cm
AB-4359S		Lancet ▽	3/8	13.0mm	0.43mm	50cm
AB-3801		Taper Point ○	3/8	13.0mm	0.38mm	45cm
AB-3801S		Taper Point ○	3/8	13.0mm	0.38mm	45cm
AB-3851		Taper Point ○	3/8	13.0mm	0.38mm	55cm
AB-3861		Taper Point ○	3/8	16.0mm	0.38mm	45cm
AB-4302S		Cut Taper Ⓡ	3/8	14.0mm	0.43mm	75cm
AB-4300		Reverse Cut ▼	7/16	13.0mm	0.43mm	45cm
AB-5351		Taper Point ○	1/2	16.0mm	0.53mm	75cm
AB-4360		Dia Spatula ◀	1/4	6.5mm	0.43mm	60cm
AB-3857		Taper Point ○	7/16	25.0mm	0.38mm	45cm



Green Braided

White Braided



POLYGLYCOLIC ACID

Sold 12 per box.  Represents a single arm suture.  Represents a double arm suture.



10-0 (0.2 METRIC)

Item #	Image	Edgemark	Curve	Needle Length	Diameter	Material Length
AXI4040		Trape Spatula ▽	3/8	6.4mm	0.20mm	30cm
AXI4039		Trape Spatula ▽	1/2	6.0mm	0.15mm	30cm



9-0 (0.3 METRIC)

Item #	Image	Edgemark	Curve	Needle Length	Diameter	Material Length
AXI4041		Trape Spatula ▽	3/8	6.4mm	0.20mm	30cm
AXI4042		Trape Spatula ▽	1/2	6.0mm	0.15mm	30cm
AXI4043		Trape Spatula ▽	1/2	6.0mm	0.15mm	30cm





POLYGLYCOLIC ACID (continued)

Sold 12 per box.  Represents a single arm suture.  Represents a double arm suture.





8-0 (0.4 METRIC)

Item #	Image	Edgemark	Curve	Needle Length	Diameter	Material Length
AB-2090		Trape Spatula 	3/8	6.5mm	0.20mm	30cm



7-0 (0.5 METRIC)

Item #	Image	Edgemark	Curve	Needle Length	Diameter	Material Length
AB-2091		Trape Spatula 	3/8	6.5mm	0.20mm	30cm
AB-2092		Trape Spatula 	7/16	5.5mm	0.20mm	45cm

6-0 (0.7 METRIC)

Item #	Image	Edgemark	Curve	Needle Length	Diameter	Material Length
AB-2490		Trape Spatula 	1/4	6.5mm	0.24mm	45cm
AB-2890		Dia Spatula 	1/4	8.5mm	0.28mm	45cm

5-0 (1.0 METRIC)

Item #	Image	Edgemark	Curve	Needle Length	Diameter	Material Length
AB-3391		Dia Spatula 	1/4	8.5mm	0.33mm	45cm



RETROBULBARS AND PERIBULBARS

All cannulas are sold 10 per box.



ATKINSON

Item #	Description	Image
AXI0414	Retrobulbar Needle 23g x 38mm (1 1/2")	
AXIII637	Retrobulbar Needle 25g x 38mm (1 1/2")	
AXI4571	Retrobulbar Needle 27g x 38mm (1 1/2")	
AXI0853	Peribulbar Needle 23g x 32mm (1 1/4")	
AXIII642	Peribulbar Needle 25g x 32mm (1 1/4")	
AXI2045	Peribulbar Needle 27g x 32mm (1 1/4")	
AXI4577	Peribulbar Needle 23g x 22mm (7/8")	
AXII5027	Peribulbar Needle 25g x 22mm (7/8")	
AXI4568	Peribulbar Needle 27g x 22mm (7/8")	
AXI4572	Peribulbar Needle 25g x 16mm (5/8")	
AXI4576	Peribulbar Needle 23g x 16mm (5/8")	

RETROBULBARS AND PERIBULBARS (continued)

All cannulas are sold 10 per box.

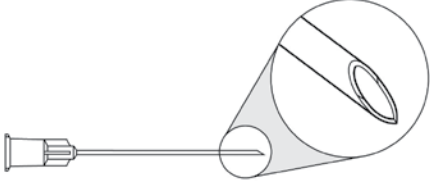
NON ATKINSON

Item #	Description	Image
AXI4580	Retrobulbar Needle 25g x 38mm (1 1/2")	
AXI4581	Retrobulbar Needle 26g x 38mm (1 1/2")	
AXI4582	Retrobulbar Needle 27g x 38mm (1 1/2")	
AXI4583	Peribulbar Needle 25g x 25mm (1")	
AXI4584	Peribulbar Needle 25g x 22mm (7/8")	
AXI4585	Peribulbar Needle 23g x 16mm (5/8")	
AXI4586	Peribulbar Needle 25g x 16mm (5/8")	
AXI4587	Peribulbar Needle 27g x 16mm (5/8")	
AXI4588	Peribulbar Needle 30g x 16mm (5/8")	

SUB TENON ANESTHESIA CANNULAS

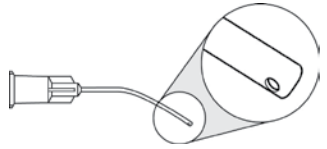
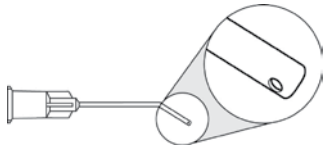
Item #	Description	Image
AXI0914	Sub Tenon Anesthesia Cannula 19g x 25mm (1") curved, flattened tip	
AXI4590	Sub Tenon Anesthesia Cannula 21g x 22mm (7/8") curved, tri port	
AXI4592	Sub Tenon Anesthesia Cannula 19g x 25mm (1") curved, tri port	
AXI4591	Sub Tenon Anesthesia Cannula 21g x 22mm (7/8") 7mm angled tip, tri port	
AXI4593	Sub Tenon Anesthesia Cannula 19g x 25mm (1") 7mm angled tip, tri port	
AXI4594	Rous Sub Tenon/Parabulbar Needle 19g x 25mm (1") 7mm angled tip, tri port	

ANTERIOR CHAMBER CANNULAS

All cannulas are sold 10 per box.

Anterior Chamber Cannulas (also known as: Air Injection, Rycroft, and Viscoelastic Cannulas) have the following specifications:

- Angle - 32°
- Length - 22mm (7/8")
- *Please Note: 19g and 20g cannulas are 25mm (1")*
- Tumble polished tips for smoother radii

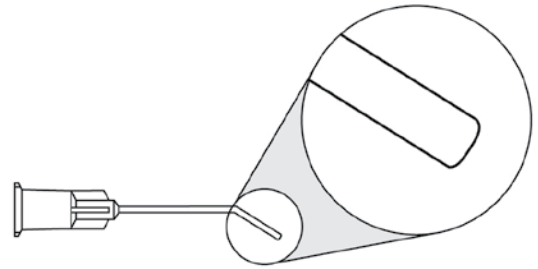

ANGLED

	3mm	4mm	5mm	6mm	7mm	8mm	9mm	10mm	11mm	12mm
30g	AXI4595	AXI21273	AXI4597	AXI21276	AXI11630	AXI21278	AXI4601	AXI4602	AXI4603	AXI4604
27g	AXI4605	AXI21273A	AXI4607	AXI21276A	AXI1463	AXI1956	AXI4611	AXI21274	AXI4613	AXI4614
25g	AXI4615	AXI21639	AXI4617	AXI2080	AXI4619	AXI21638	AXI4621	AXI21280	AXI4623	AXI4624
23g	AXI4625	AXI3254	AXI4627	AXI4628	AXI4629	AXI4630	AXI4631	AXI4632	AXI4633	AXI4634
21g	AXI4635	AXI4636	AXI4637	AXI4638	AXI4639	AXI4640	AXI4641	AXI4642	AXI4643	AXI4644
20g	AXI4645	AXI4646	AXI4647	AXI4648	AXI21277B	AXI1261	AXI4651	AXI4652	AXI4653	AXI4654
19g	AXI4655	AXI4656	AXI4657	AXI4658	AXI4659	AXI4660	AXI4661	AXI4662	AXI4663	AXI4664



STRAIGHT AND FORMED

Item #	Description	Image
AXI4665	Anterior Chamber Cannula (straight) 30g x 22mm (7/8")	
AXI4667	Anterior Chamber Cannula (straight) 27g x 22mm (7/8")	
AXI4669	Anterior Chamber Cannula (straight) 25g x 22mm (7/8")	
AXI4671	Anterior Chamber Cannula (straight) 23g x 22mm (7/8")	
AXI4672	Anterior Chamber Cannula (straight) 23g x 32mm (1 1/4")	
AXI4674	Anterior Chamber Cannula (straight) 21g x 22mm (7/8")	
AXI4676	Anterior Chamber Cannula (straight) 20g x 25mm (1")	
AXI4678	Anterior Chamber Cannula (straight) 19g x 25mm (1")	
AXI4680	Viscoelastic Cannula (formed) 27g x 22mm (7/8"), formed 11mm from tip	

ANTERIOR CHAMBER CANNULAS (continued)

All cannulas are sold 10 per box.

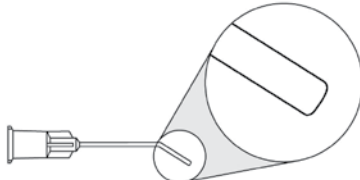
ANGLED AND CURVED

Item #	Description	Image
AXI2I279A	Viscoelastic Cannula (angled) 27g x 22mm (7/8"), 9mm bend	
AXI4613	Viscoelastic Cannula (angled) 27g x 22mm (7/8"), 11mm bend	
AXI4666	Anterior Chamber Cannula (curved) 30g x 22mm (7/8")	
AXI4668	Anterior Chamber Cannula (curved) 27g x 22mm (7/8")	
AXI4670	Anterior Chamber Cannula (curved) 25g x 22mm (7/8")	
AXI4673	Anterior Chamber Cannula (curved) 23g x 22mm (7/8")	
AXI4675	Anterior Chamber Cannula (curved) 21g x 22mm (7/8")	
AXI4677	Anterior Chamber Cannula (curved) 20g x 25mm (1")	
AXI4679	Anterior Chamber Cannula (curved) 19g x 25mm (1")	

ANTERIOR CHAMBER CANNULAS, THIN WALL

All cannulas are sold 10 per box.

Thin Wall Cannulas allow the advantages of a larger bore through a smaller cannula. The inside diameter is approximately 2 gauge sizes larger, therefore a 25g T.W. lumen is approximately the same as the inside lumen on a 23g.

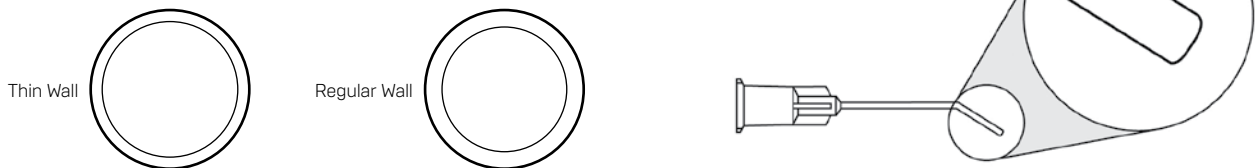

ANGLED

	3mm	4mm	5mm	6mm	7mm	8mm	9mm	10mm	11mm	12mm
25gTW	AXI4681	AXI4682	AXI4683	AXI4684	AXI4685	AXI4686	AXI4687	AXI4688	AXI4689	AXI4690
23gTW	AXI4691	AXI4692	AXI4693	AXI4694	AXI4695	AXI4696	AXI4697	AXI4698	AXI4699	AXI4700

ANTERIOR CHAMBER CANNULAS, THIN WALL (continued)

All cannulas are sold 10 per box.

STRAIGHT AND CURVED

Item #	Description	Image
AXI4701	Anterior Chamber Cannula (straight) 25g x 22mm (7/8"), Thin Wall	
AXI4703	Anterior Chamber Cannula (straight) 23g x 22mm (7/8"), Thin Wall	
AXI4702	Anterior Chamber Cannula (curved) 25g x 22mm (7/8"), Thin Wall	
AXI4704	Anterior Chamber Cannula (curved) 23g x 22mm (7/8"), Thin Wall	

I/A CANNULAS AND CORTEX REMOVAL

All cannulas are sold 10 per box.

Item #	Description	Image
AXI4705	Double I/A Cannula 21g/ 21g, side port 0.3mm	
AXI4707	Double I/A Cannula 21g/ 21g, open end	
AXI4708	Double I/A Cannula 21g/ 19g, open end	
AXI4706	"J" Shaped Double I/A Cannula 23g/ 25g, side port 0.2mm	
AXI61571	Double Barrel I/A Cannula [Simcoe] 23g/ 23g x 16mm (5/8"), curved, sideport 0.3mm 6" silicone tubing: ID - 0.75mm [0.030"] OD - 1.65mm [0.065"]	
AXI4710	Reverse Double Barrel I/A Cannula [Simcoe] 23g/ 23g x 16mm (5/8"), curved, sideport 0.3mm 6" silicone tubing: ID - 0.75mm [0.030"] OD - 1.65mm [0.065"]	
AXI4679	Anterior Chamber Cannula (curved) 19g x 25mm (1")	

I/A CANNULAS AND CORTEX REMOVAL (continued)

All cannulas are sold 10 per box.

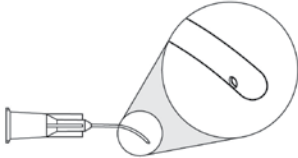
Item #	Description	Image
AXI4711	Cortex Extractor [Simcoe] 23g x 13mm (½"), curved, side port 0.3mm	
AXI55075	Cortex Extractor [Simcoe] 23g x 22mm (7⁄8"), curved, side port 0.3mm	
AXI4713	Cortex Extractor [Charleux] 23g x 13mm (½"), curved	

BUTTON COAXIAL I/A SYSTEM

All cannulas are sold 10 per box.

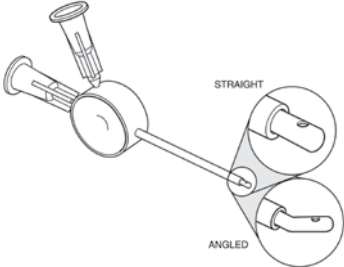
Item #	Description	Image
AXI4715	Button Coaxial I/A System (straight) 17g thin wall outer cannula, 21g inner cannula, 30mm length, 0.3mm side port	
AXI4714	Button Coaxial I/A System (angled) 17g thin wall outer cannula, 21g inner cannula, 30mm length, angled 30°, 0.3mm side port	

"J" SHAPED CANNULAS

All cannulas are sold 10 per box.

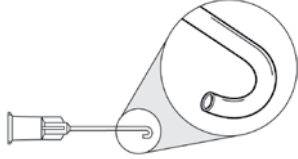
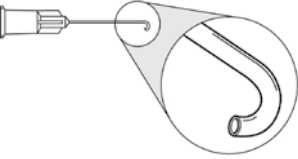
Item #	Description	Image
AXI51287	"J" Shaped Cannula 30g x 22mm (7⁄8"), "J" shape 1.5mm high x 1.5mm wide	
AXI51297	"J" Shaped Cannula 27g x 22mm (7⁄8"), "J" shape 1.5mm high x 1.5mm wide	
AXI0761	"J" Shaped Cannula 25g x 22mm (7⁄8"), "J" shape 1.5mm high x 1.5mm wide	
AXI4723	"J" Shaped Cannula 23g x 22mm (7⁄8"), "J" shape 2mm high x 2mm wide	
AXI4725	"J" Shaped Cannula 21g x 22mm (7⁄8"), "J" shape 2mm high x 2mm wide	
AXI4722	Micro "J" Shaped Cannula [Hessburg] 25g x 22mm (7⁄8"), "J" shape 0.85mm long x 1.7mm wide	

“J” SHAPED CANNULAS (continued)

All cannulas are sold 10 per box.

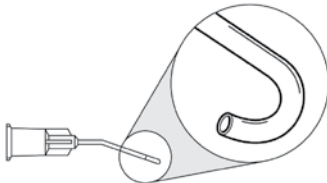
Item #	Description	Image
AXI4719	“J” Shaped Cannula 25g x 22mm (7/8”), 10mm angled tip (45°) “J” shape 2mm high x 2mm wide	
AXI4724	“J” Shaped Cannula 23g x 22mm (7/8”), 10mm angled tip (45°) “J” shape 2mm high x 2mm wide	
AXI4720	“J” Shaped Cannula [angled left] [Binkhorst] 25g x 22mm (7/8”), 12mm angled tip (18°), “J” shape 1.5mm high x 1.75mm wide	
AXI4721	“J” Shaped Cannula [angled right] [Binkhorst] 25g x 22mm (7/8”), 12mm angled tip (18°) “J” shape 1.5mm high x 1.75mm wide	



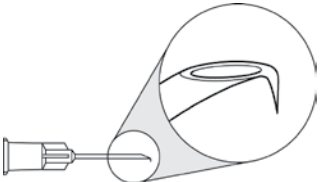
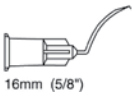
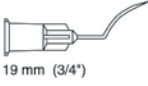
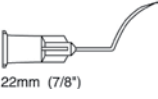

CYSTOTOMES

All cannulas are sold 10 per box.

Item #	Description	Image	
AXI4726	Irrigating Cystotome (straight) 30g x 16mm (5/8”)		
AXI4727	Irrigating Cystotome (straight) 27g x 16mm (5/8”)		
AXI4728	Irrigating Cystotome (straight) 27g x 19mm (3/4”)		
AXI31610A	Irrigating Cystotome (straight) 25g x 16mm (5/8”)		
AXI4730	Irrigating Cystotome (straight) 25g x 22mm (7/8”)		
AXI4731	Irrigating Cystotome (straight) 23g x 16mm (5/8”)		
AXI4732	Irrigating Cystotome (straight) 23g x 19mm (3/4”)		
AXI4736	Irrigating Cystotome (formed) 30g x 16mm (5/8”)		
AXI31618	Irrigating Cystotome (formed) 27g x 16mm (5/8”)		
AXI4735	Irrigating Cystotome (formed) 27g x 19mm (3/4”)		
AXI31610	Irrigating Cystotome (formed) 25g x 16mm (5/8”)		
AXI4737	Irrigating Cystotome (formed) 25g x 22mm (7/8”)		
AXI31599	Irrigating Cystotome (formed) 23g x 16mm (5/8”)		
AXI4739	Irrigating Cystotome (formed) 23g x 19mm (3/4”)		

CYSTOTOMES (continued)

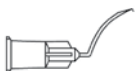
All cannulas are sold 10 per box.

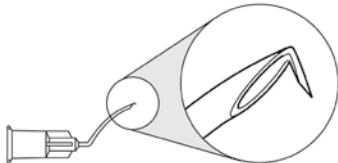
Item #	Description	Image
AXI35093	Irrigating Cystotome (angled) 27g x 16mm (5/8")	
AXI35049	Irrigating Cystotome (angled) 25g x 16mm (5/8")	
AXI4742	Irrigating Cystotome [Joyce] 27g x 16mm (5/8"), curved	
AXI4743	Irrigating Cystotome [Joyce] 25g x 16mm (5/8"), curved	
AXI1348	Irrigating Cystotome (side cut) 25g x 16mm (5/8")	
AXI4745	Irrigating Cystotome (small radius) 27g x 16mm (5/8")	
AXI35004	Irrigating Cystotome (small radius) 25g x 16mm (5/8")	
AXI1891	Irrigating Cystotome (reverse formed) 25g x 16mm (5/8"), tip angled 90° towards bevel	

CAPSULORHEXIS CYSTOTOMES

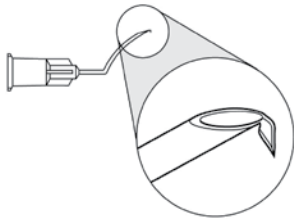
Item #	Description	Image
AXI35042	Capsulorhexis Cystotome (formed) 27g x 16mm (5/8"), tip twisted 90°	
AXI4749	Capsulorhexis Cystotome (straight) 27g x 16mm (5/8"), tip twisted 90°	
AXI35113	Capsulorhexis Cystotome (formed) 25g x 16mm (5/8"), tip twisted 90°	
AXI4751	Capsulorhexis Cystotome (straight) 25g x 16mm (5/8"), tip twisted 90°	
AXI4752	Capsulorhexis Cystotome (formed) 23g x 16mm (5/8"), tip twisted 90°	
AXI4753	Capsulorhexis Cystotome (straight) 23g x 16mm (5/8"), tip twisted 90°	

IRRIGATING SHARP CYSTOTOMES

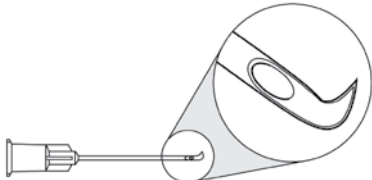
Item #	Description	Image
AXI4754	Irrigating Sharp Cystotome (straight) [Kelman] 22g x 25mm (1")	
AXI4755	Irrigating Double Sharp Cystotome (straight) [Kelman] 22g x 25mm (1")	

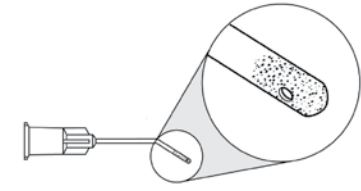
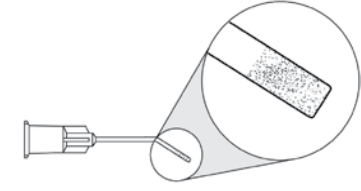
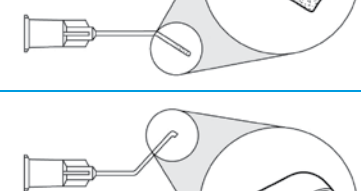
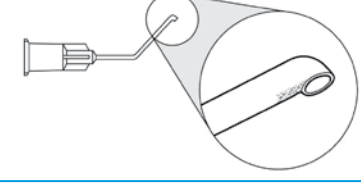
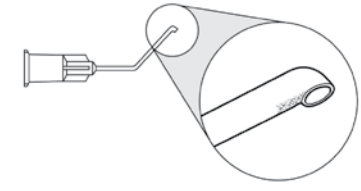
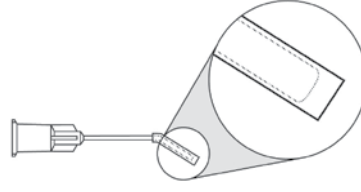
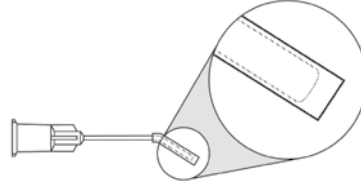
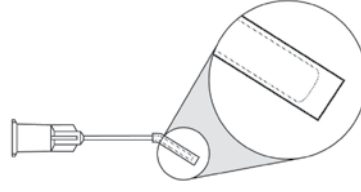

CAPSULE POLISHERS

All cannulas are sold 10 per box.

Item #	Description	Image
AXI4756	Capsule Polisher (side port) 21g x 22mm (7/8"), 7mm angled tip (37°), 3mm sandblasted closed distal end, 0.3mm side port	
AXI4757	Capsule Polisher (side port) 23g x 22mm (7/8"), 7mm angled tip (37°), 3mm sandblasted closed distal end, 0.3mm side port	
AXI4758	Capsule Polisher (open end) 21g x 22mm (7/8"), 7mm angled tip (37°), 3mm sandblasted distal end	
AXI4759	Capsule Polisher (open end) 23g x 22mm (7/8"), 7mm angled tip (37°), 3mm sandblasted distal end	
AXI4760	Posterior Capsule Scraper 23g x 22mm (7/8"), 12mm angled tip (45°), 2mm sandblasted distal end angled 90°	
AXI75041	Silicone Tip Capsule Polisher (Squeegee) 23g x 22mm (7/8"), 7mm angled tip (32°), 10mm silicone tubing, 0.5mm (0.020") ID X 0.95mm (0.037") OD, extends over bend to ensure secure placement of tubing on cannula	
AXI75005	Silicone Tip Capsule Polisher (Squeegee) 27g x 22mm (7/8"), 7mm angled tip (32°), 10mm silicone tubing, 0.3mm (0.012") ID X 0.6mm (0.025") OD, extends over bend to ensure secure placement of tubing on cannula	
AXI4763	Silicone Tip Capsule Polisher (Squeegee) 23g x 22mm (7/8"), 9mm angled tip (32°), 12mm silicone tubing, 0.5mm (0.020") ID X 0.95mm (0.037") OD, extends over bend to ensure secure placement of tubing on cannula	



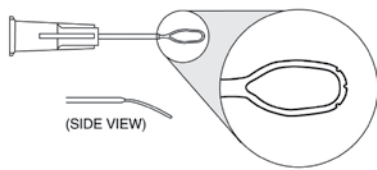
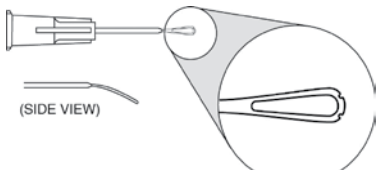

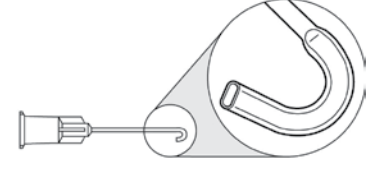
NUCLEUS REMOVAL, IRRIGATING, HYDRODISSECTION AND HYDRODELINEATION

All cannulas are sold 10 per box.

Item #	Description	Image
AXI4764	Irrigating Vectis (1 port) 24g, 5mm width, 0.3mm port	
AXI4767	Irrigating Vectis (3 port) 24g, 5mm width, 0.3mm port	
AXI4765	Irrigating Vectis (1 port) 24g, 3mm width, 0.3mm port	
AXI4766	Irrigating Vectis (2 port) 24g, 4mm width, 0.3mm port	
AXI65040	Anterior Chamber Washout Cannula 19g x 25mm (1"), 8mm angled tip (37°), smooth oval shaped tip	
AXI3014	Hydrodissection Cannula 30g x 22mm (7/8"), 8mm angled (32°), flattened tip, smooth oval shaped tip	
AXI25158	Hydrodissection Cannula 27g x 22mm (7/8"), 8mm angled (32°), flattened tip, smooth oval shaped tip	
AXI25037	Hydrodissection Cannula 25g x 22mm (7/8"), 8mm angled (32°), flattened tip, smooth oval shaped tip	
AXI4772	Hydrodissection Cannula 23g x 22mm (7/8"), 8mm angled (32°), flattened tip, smooth oval shaped tip	
AXI4773	"J" Shaped Hydrodissection Cannula 30g x 22mm (7/8"), "J" shape, 1.5mm high x 1.5mm wide, smooth oval shaped tip	
AXI25029	"J" Shaped Hydrodissection Cannula 27g x 22mm (7/8"), "J" shape, 1.5mm high x 1.75mm wide, smooth oval shaped tip	
AXI4775	"J" Shaped Hydrodissection Cannula 25g x 22mm (7/8"), "J" shape, 1.5mm high x 2mm wide, smooth oval shaped tip	

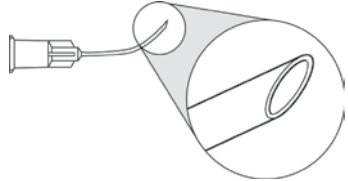

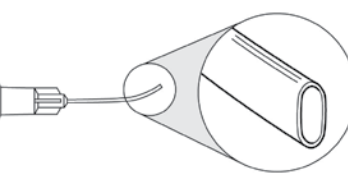

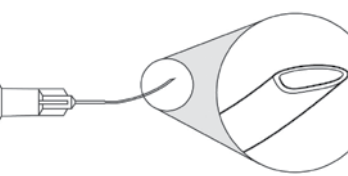
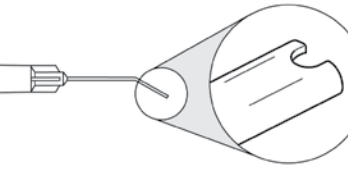
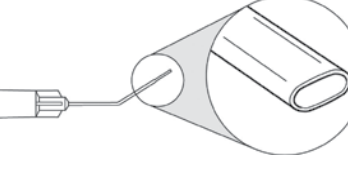
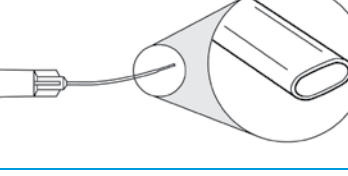
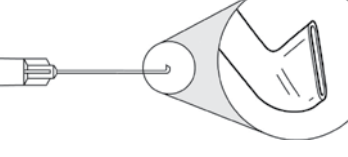

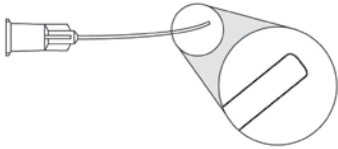
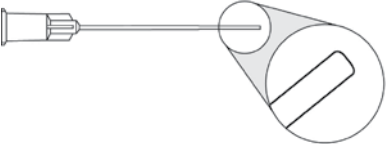

NUCLEUS REMOVAL, IRRIGATING, HYDRODISSECTION AND HYDRODELINEATION [continued]

All cannulas are sold 10 per box.

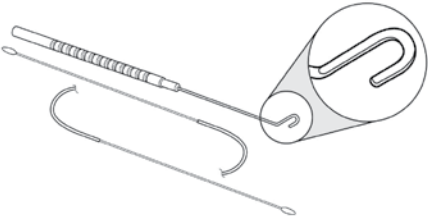
Item #	Description	Image
AXI4776	Hydrodelineation Needle [Kellan] 25g x 22mm (7/8"), shortened bevel	
AXI4777	Hydrodelineation Needle [Kellan] 27g x 22mm (7/8"), shortened bevel	
AXI4778	Hydrodissection Cannula [Kellan] 25g x 22mm (7/8"), curved	
AXI2I273D	Hydrodissection Cannula [Kellan] 27g x 22mm (7/8"), curved	
AXI4780	Nucleus Hydrolysis Needle [P. Koch] 25g x 22mm (7/8"), curved, flattened	
AXI4781	Nucleus Hydrodissector/Rotator [Sinsky] 25g x 22mm (7/8"), 8mm angled tip (32°), forked blunt tip	
AXI25157	Cortical Cleaving Hydrodissector 27g x 22mm (7/8"), angled 11mm from end, tip flattened horizontally 4mm from end	
AXI25155	Nucleus Hydrodissector (curved) 27g x 22mm (7/8"), tip flattened horizontally 4mm from end	
AXI4784	Hydrodissection Cannula [Chang] 27g x 22mm (7/8")	

MISCELLANEOUS INSTRUMENTS







All cannulas are sold 10 per box.

Item #	Description	Image
AXI4785	Lacrimal Cannula (curved) 25g x 28mm (1 1/8"), tumble polished edge	
AXI4786	Lacrimal Cannula (straight) 19g tapered to 23g 12mm from edge	
AX585010	Lacrimal Intubation Set stainless steel probes: 23g x 175mm (7"), silicone tubing length: 300mm (12"), tubing dimensions: 0.3mm (.012") x 0.6mm (.025")	
AXI4788	Lacrimal Intubation Set stainless steel probes: 23g x 110mm (4 1/4") with bulbous tips silicone tubing length: 300mm (12"), tubing dimensions: 0.3mm (.012") x 0.6mm (.025") retriever is stainless steel with a 0.75mm opening on a ribbed autoclavable plastic handle. handle length: 75mm (3")	
AXI4789	Lacrimal Intubation Set (no retriever)	
AXI4790	DCR Set (straight) stainless steel probes: 20g x 45mm (1 3/4") silicone tubing length: 300mm (12"), tubing dimensions: 0.5mm (.020") x 0.95mm (.037")	
AXI4791	DCR Set (angled) stainless steel probes: 20g x 45mm (1 3/4") silicone tubing length: 300mm (12"), tubing dimensions: 0.5mm (.020") x 0.95mm (.037")	
AXI4792	Stiletto Knife 20g 1.15mm width, handle* length 75mm (3")	
AXI4793	Stiletto Knife 19g 1.38mm width, handle* length 75mm (3")	
AXI4794	Micro Lens Hook (straight) [Sinskey II] used for 0.2mm holes or larger, handle* length 75mm (3")	
AXI4795	Micro Lens Hook (angled) [Sinskey II] 10mm angled tip (45°), used for 0.2mm holes or larger handle* length 75mm (3")	

*Ribbed non-slip handle

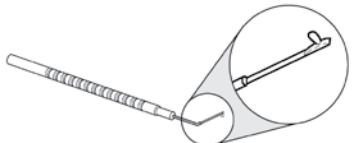
MISCELLANEOUS INSTRUMENTS (continued)

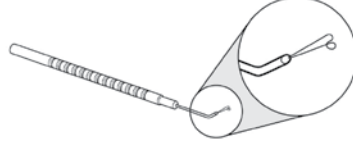





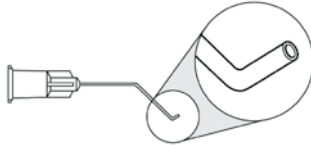

All cannulas are sold 10 per box.

Item #	Description	Image
AXI4796	Lens Manipulating Hook [Fenzl] 10mm angled tip (45°), used for 0.2mm holes or larger, handle* length 75mm (3")	
AXI4797	Button Tip Manipulator (angled) 10mm angled tip (45°), handle* length 75mm (3")	
AXI4798	Lens Manipulator [Jaffe-Maltzman] (angled) 10mm angled tip (45°), "V" shaped blunt tip, handle* length 75mm (3")	
AXI4799	IOL Manipulating Hook [Lester] (angled) 10mm angled tip (45°), hourglass shaped tip, handle* length 75mm (3")	
AXI4800	Nucleus Rotator [Jaffe-Bechert] (angled) 7mm angled tip (45°), "Y" shaped blunt tip, handle* length 75mm (3")	
AXI4801	Micro Iris Retractor [Pearce] (angled) 1mm wide tip*	
AXI4803	Nucleus Spatula [Pearce] 0.80mm wide x 0.20mm thick, 10mm angled tip* (45°)	
AXI4804	Nucleus Chopper [P.Koch] (angled) 6mm angled tip (45°), handle* length 75mm (3")	

*Ribbed non-slip handle

MISCELLANEOUS INSTRUMENTS (continued)

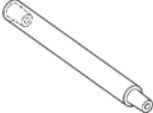
All cannulas are sold 10 per box.

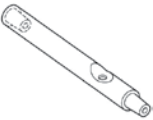
Item #	Description	Image
AXI4802	Irrigating Dialer 30g x 22mm (7/8"), 10mm angled tip (45°), 1mm distal end angled 65°	
AXI4805	Eye Speculum (adult) [Barraquer]	
AXI4806	Eye Speculum (child) [Barraquer]	
AXI4807	Eye Speculum (adult) [Kratz] open blades	
AXI4808	Alpha-chymotrypsin Cannula (curved) 25g x 28mm (1 1/8"), 1mm smooth, bulbous tip	
AXI4809	Olive Tip Capsule Polisher (curved) 25g x 28mm (1 1/8"), 1mm sandblasted, bulbous tip	
AXI4810	Olive Tip Cannula (curved) 23g x 22mm (7/8"), 1mm smooth, bulbous tip	
AXI4811	Olive Tip Capsule Polisher (curved) 23g x 22mm (7/8"), 1mm sandblasted, bulbous tip	
AXI4812	Olive Tip Capsule Polisher 23g x 10mm bend (angled), 1mm sandblasted, bulbous tip	
AXI4813	Infusion Handle 75mm (3"), luer slip end and tapered tubing end made with autoclavable plastic	
AXI4814	Male/Female Hand Piece 75mm (3"), fits luer taper on both ends made with autoclavable plastic	
AXI4815	Double Male Hand Piece 50mm (2"), fits luer taper on both ends made with autoclavable plastic	
AXI4816	Aspirating Hand Piece with finger hole 75mm (3"), fits luer taper on both ends made with autoclavable plastic	

*Ribbed non-slip handle

CHAMBER MAINTAINERS AND RETINAL CANNULAS

All cannulas are sold 10 per box.

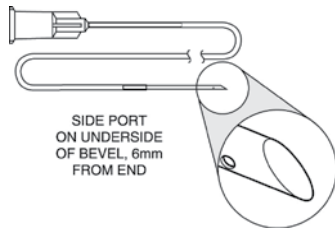
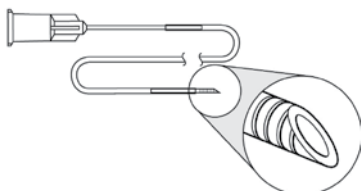
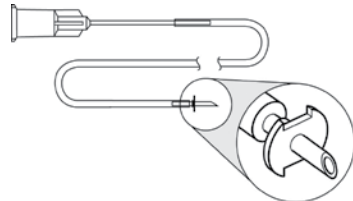
Item #	Description	Image
AXI4817	Chamber Maintainer 27g x 22mm (7/8"), 0.2mm side port, sharp closed end 6" silicone tubing: ID - 0.3mm (0.012") OD - 0.6mm (0.025")	 <p>SIDE PORT ON UNDERSIDE OF BEVEL, 6mm FROM END</p>
AXI4818	Chamber Maintainer 25g x 22mm (7/8"), 0.2mm side port, sharp closed end 6" silicone tubing: ID - 0.3mm (0.012") OD - 0.6mm (0.025")	
AXI4819	Chamber Maintainer 23g x 22mm (7/8"), 0.3mm side port, sharp closed end 6" silicone tubing: ID - 0.5mm (0.020") OD - 0.95mm (0.037")	
AXI4820	Chamber Maintainer 20g x 22mm (7/8"), 0.3mm side port, sharp closed end 6" silicone tubing: ID - 0.75mm (0.030") OD - 1.65mm (0.065")	
AXI4821	Chamber Maintainer with serrated tip 25g x 22mm (7/8"), 4mm serrated tip 6" silicone tubing: ID - 0.3mm (0.012") OD - 0.6mm (0.025")	
AXI4822	Chamber Maintainer with serrated tip 23g x 22mm (7/8"), 4mm serrated tip 6" silicone tubing: ID - 0.5mm (0.020") OD - 0.95mm (0.037")	
AXI4823	Chamber Maintainer with serrated tip 20g x 22mm (7/8"), 4mm serrated tip 6" silicone tubing: ID - 0.75mm (0.030") OD - 1.65mm (0.065")	
AXI4824	Infusion Cannula 20g, 2.5mm tip, 6" silicone tubing: ID - 0.75mm (0.030") OD - 1.65mm (0.065")	
AXI4825	Infusion Cannula 20g, 4mm tip, 6" silicone tubing: ID - 0.75mm (0.030") OD - 1.65mm (0.065")	
AXI4826	Infusion Cannula 20g, 6mm tip, 6" silicone tubing: ID - 0.75mm (0.030") OD - 1.65mm (0.065")	





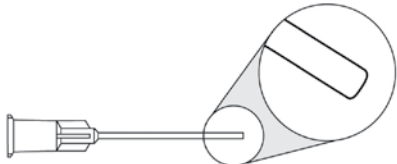
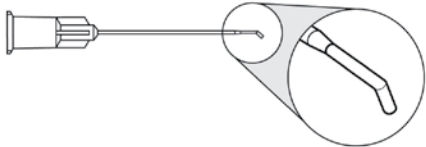
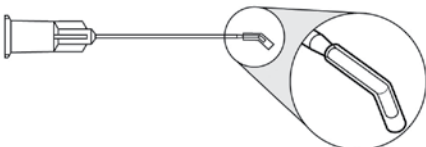
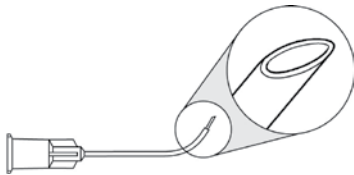



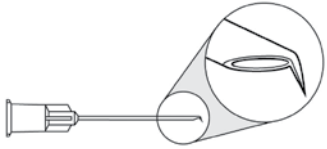

CHAMBER MAINTAINERS AND RETINAL CANNULAS (continued)

All cannulas are sold 10 per box.

Item #	Description	Image
AXI4827	Extrusion Cannula (straight, blunt) 20g x 25mm (1"), tumble polished edge	
AXI4832	Extrusion Cannula (straight, blunt) 19g x 25mm (1"), tumble polished edge	
AXI4837	Extrusion Cannula (straight, blunt) 23g x 22mm (7/8"), tumble polished edge	
AXI4828	Extrusion Cannula (straight, tapered) 20g x 25mm (1"), tumble polished edge, tapered to 25g, 4mm from end	
AXI4833	Extrusion Cannula (straight, tapered) 19g x 25mm (1"), tumble polished edge, tapered to 23g, 4mm from end	
AXI4830	Extrusion Cannula (angled, tapered) 20g x 25mm (1"), tumble polished edge, tapered to 25g, 4mm from end, 1mm distal end angled 45°	
AXI3835	Extrusion Cannula (angled, tapered) 19g x 25mm (1"), tumble polished edge, tapered to 23g, 4mm from end, 1mm distal end angled 45°	
AXI4829	Extrusion Cannula with silicone tubing (straight, tapered) 20g x 25mm (1"), tapered to 25g, 4mm from end tubing: ID - 0.3mm (0.012"); OD - 0.6mm (0.025") extends 8mm beyond tip (can be cut to desired length)	
AXI4834	Extrusion Cannula with silicone tubing (straight, tapered) 19g x 25mm (1"), tapered to 23g, 4mm from end tubing: ID - 0.3mm (0.012"); OD - 0.6mm (0.025") extends 8mm beyond tip (can be cut to desired length)	
AXI4831	Extrusion Cannula with silicone tubing (angled, tapered) 20g x 25mm (1"), tapered to 25g, 4mm from end tubing: ID - 0.3mm (0.012"); OD - 0.6mm (0.025") extends 8mm beyond tip (can be cut to desired length)	
AXI4836	Extrusion Cannula with silicone tubing (angled, tapered) 19g x 25mm (1"), tapered to 23g, 4mm from end tubing: ID - 0.3mm (0.012"); OD - 0.6mm (0.025") extends 8mm beyond tip (can be cut to desired length)	
AXI4838	High Viscosity Fluid Cannula [Peyman] 16g x 9mm (3/8")	
		

CHAMBER MAINTAINERS AND RETINAL CANNULAS (continued)

All cannulas are sold 10 per box.

Item #	Description	Image
AXI4839	Membrane Dissector [Kingham] 20g x 25mm (1"), 0.5mm sharp tip angled 45 towards bevel	
AXI4840	Subretinal Injector [Lambert] 20g x 25mm (1"), tapered to 33g x 7mm, curved distal end	
AXI4841	Subretinal Aspirator [Landers] 20g x 25mm (1"), tapered to 27g x 6mm, angled 2.5mm from tip	
AXI4842	Flute Needle [Charles] 19g x 25mm (1")	
AXI4843	Membrane Micropick [Eaton] 20g x 25mm (1"), tapered to 30g x 5mm distal end, 0.5mm sharp tip angled 50° towards bevel	
AXI4844	Vitreoretinal Micropick [Glaser] 20g x 25mm (1"), tapered to 25g x 3/16" distal end, 0.5mm sharp tip angled 50° towards bevel	
AXI4845	Vitreoretinal Micropick [Glaser] 23g x 25mm (1"), tapered to 27g x 3/16" distal end, 0.5mm sharp tip angled 50° towards bevel	
AXI4846	Vitreoretinal Cannula [Vander] 20g tapered to 30g (straight)	
AXI4847	Vitreoretinal Cannula [Vander] 20g tapered to 30g (angled)	
AXI4848	Subretinal Injector [Glaser] 20g x 25mm (1"), tapered to 33g x 3mm distal end (curved)	

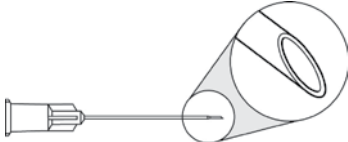
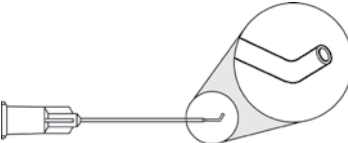
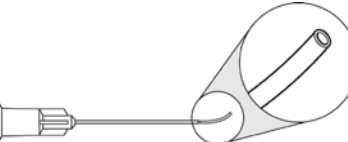

CHAMBER MAINTAINERS AND RETINAL CANNULAS (continued)

All cannulas are sold 10 per box.

Item #	Description	Image
AXI4849	Subretinal Injector [Glaser] 20g x 25mm (1"), tapered to 33g x 3mm, distal end (straight)	
AXI4850	MVR Cannula [Glaser] 20g x 25mm (1"), tapered to 33g x 4mm, distal end angled 1mm from tip	
AXI4851	Subretinal Cannula [Lambert] 20g x 25mm (1"), tapered to 33g x 7mm, curved distal end	

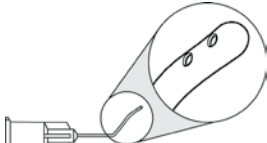

LASIK CANNULAS

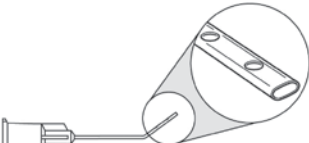
All cannulas are sold 10 per box.

Item #	Description	Image
AXI4852	[Dishler] Lasik Cannula 27g x 16mm (5/8"), formed 9mm, 4 side ports	
AXI4853	[Slade] Lasik Cannula 26g x 22mm (7/8"), formed 9mm	
AXI4855	Linn Lasik Cannula 25g x 9mm flat bend (2 ports, open end)	

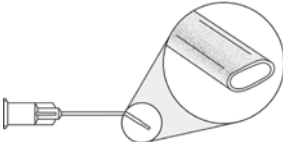

FEMTOSECOND CANNULAS

All cannulas are sold 10 per box.

Item #	Description	Image
AX15227	<p>Solomon Femtosecond Cannula 30g hydrodissector, 7mm bend, sandblasted tip The fine texture will help to manipulate the capsule to ensure free floating, and then the hydrodissection can be followed with gentle polishing of the anterior leaflets.</p>	
AX20001	<p>Brody Femtosecond Dissecting Cannula 25g stainless steel spatula and cannula combo, shovel-like tip. Designed for Laser-assisted cataract surgery and easily opens laser incisions and allows for fast, efficient injection of intraocular lidocane and/or viscoelastic.</p>	

DROPLESS CATARACT SURGERY CANNULA

All cannulas are sold 10 per box.

Item #	Description	Image
AX15581	<p>AccuDrop Dropleless Cataract Cannula 25g, angled shaft, 90 degree bend, blunt tip cannula with a side port opening that allows for gentle drug dispersion. Blunt tip reduces zonular trauma and the angled shaft facilitates easier insertion into the anterior chamber.</p>	
AX15630	<p>AccuDrop Dropleless Cataract Cannula 27g, angled shaft, 90 degree bend, blunt tip cannula with a side port opening that allows for gentle drug dispersion. Blunt tip reduces zonular trauma and the angled shaft facilitates easier insertion into the anterior chamber.</p>	













BI-MANUAL I/A SYSTEMS

Single-Use bi-manual I/A systems are a solution for preventing infection. These products are guaranteed to be sterile and safe from contaminants. Comes two handpieces per pack, one irrigating, one aspirating.

Item #	Description	Image
AB-9105B	Aspiration-handpiece 0.8 mm (2IG) with curved cannula, aspiration port 0.35 mm, textured tip for capsule polishing AEROPLANE nose shape. Irrigation-handpiece 0.8 mm (2IG) with curved cannula, irrigation port 0.50 mm for active rinsing.	
AB-9110B	Aspiration-handpiece 0.8 mm (2IG) with curved cannula, aspiration port 0.35 mm, textured tip for capsule polishing, AEROPLANE nose shape. Irrigation-handpiece 0.8 mm (2IG) with curved cannula, two irrigation ports 0.45 mm, AEROPLANE nose shape.	

MONO-MANUAL I/A SYSTEMS

This range of coaxial I/A systems features straight and angled versions at 30°, 45° and 65°. All models are available as 19G, 20G, 21G and 23G version for incisions of 2.8 to 1.8 mm. The textured aspiration tips can be used for selective polishing of the posterior capsule.

Item #	Description	Image
AB-9I35	Aspiration cannula angled 65°, for incisions of 2.5 mm, textured aspiration head.	
AB-9I10	Aspiration cannula straight, for incisions of 2.8 mm, textured aspiration head.	
AB-9I20	Aspiration cannula angled 45°, for incisions of 2.8 mm, textured aspiration head.	
AB-9I25P	Aspiration cannula angled 45°, for incisions of 2.5 mm, polished aspiration head.	
AB-9I75P	Aspiration cannula curved, for incisions of 1.8 mm, polished aspiration head.	
AB-9I60P	Aspiration cannula curved, for incisions of 2.2 mm, polished aspiration head.	
AB-9I55P	Aspiration cannula angled 45°, for incisions of 2.2 mm, polished aspiration head.	
AB-9I15	Aspiration cannula straight, for incisions of 2.5 mm, textured aspiration head.	
AB-9I70P	Aspiration cannula angled 45°, for incisions of 1.8 mm, polished aspiration head.	
AB-9I30	Aspiration cannula angled 65°, for incisions of 2.8 mm, textured aspiration head.	



RADIAL VACUUM TREPHINES

Our sterile, single-use vacuum trephines consistently create accurate and uniform cuts by dividing the corneal chamber into 16 chambers, thus reducing corneal distortion. The ergonomic grip allows for easier control while making precision cuts on patient corneas. 16 radial marks allow for easy suture placement.

Item #	Description	Image
AB-67600	6.00mm disposable, single-use vacuum trephine. Comes one per pack.	
AB-67650	6.50mm disposable, single-use vacuum trephine. Comes one per pack.	
AB-67700	7.00mm disposable, single-use vacuum trephine. Comes one per pack.	
AB-67725	7.25mm disposable, single-use vacuum trephine. Comes one per pack.	
AB-67750	7.50mm disposable, single-use vacuum trephine. Comes one per pack.	
AB-67775	7.75mm disposable, single-use vacuum trephine. Comes one per pack.	
AB-67800	8.00mm disposable, single-use vacuum trephine. Comes one per pack.	
AB-67825	8.25mm disposable, single-use vacuum trephine. Comes one per pack.	
AB-67850	8.50mm disposable, single-use vacuum trephine. Comes one per pack.	
AB-67875	8.75mm disposable, single-use vacuum trephine. Comes one per pack.	
AB-67900	9.00mm disposable, single-use vacuum trephine. Comes one per pack.	

VACUUM DONOR PUNCHES

Our sterile, single-use vacuum donor punches have an ultra sharp cutting blade for making precision cuts of the donor tissue for corneal transplants. The punches feature four guide posts that ensure proper alignment.

Item #	Description	Image
AB-60600	6.00mm disposable, single-use vacuum donor punch. Comes one per pack.	
AB-60625	6.25mm disposable, single-use vacuum donor punch. Comes one per pack.	
AB-60650	6.50mm disposable, single-use vacuum donor punch. Comes one per pack.	
AB-60675	6.75mm disposable, single-use vacuum donor punch. Comes one per pack.	
AB-60700	7.00mm disposable, single-use vacuum donor punch. Comes one per pack.	
AB-60725	7.25mm disposable, single-use vacuum donor punch. Comes one per pack.	
AB-60750	7.50mm disposable, single-use vacuum donor punch. Comes one per pack.	
AB-60775	7.75mm disposable, single-use vacuum donor punch. Comes one per pack.	
AB-60785	7.85mm disposable, single-use vacuum donor punch. Comes one per pack.	
AB-60800	8.00mm disposable, single-use vacuum donor punch. Comes one per pack.	
AB-60825	8.25mm disposable, single-use vacuum donor punch. Comes one per pack.	
AB-60850	8.50mm disposable, single-use vacuum donor punch. Comes one per pack.	
AB-60875	8.75mm disposable, single-use vacuum donor punch. Comes one per pack.	
AB-60900	9.00mm disposable, single-use vacuum donor punch. Comes one per pack.	
AB-60925	9.25mm disposable, single-use vacuum donor punch. Comes one per pack.	
AB-60950	9.50mm disposable, single-use vacuum donor punch. Comes one per pack.	







SURGICAL DISPOSABLES



SPEARS

Item #	Description	Image
AXI0085	PVA Spears 20 packs of 5	
AXI0086	PVA Spears 20 packs of 10	
AXI0087	Cellulose Spears 20 packs of 5	
AXI0088	Cellulose Spears 20 packs of 10	

IRIS RETRACTORS

Item #	Description	Image
AXI4139	Iris Retractor Nylon 5 per pack	
AXI4020	Iris Retractor Polypropylene 5 per pack	
AXI5156	Iris Retractor Reusable Polypropylene, 6 per pack	
AXI4873	Mackool Cataract Support System 5 per pack	

EYE SHIELDS



Item #	Description	Image
AXI0445	Eye Shield Clear Plastic, 50 per box	
AXI2010	Eye Shield Clear Plastic, 100 per box	
AXI0193	Eye Shield Metal with cover, 50 per box	

SURGICAL DISPOSABLES [continued]

VITRECTOMY LENSES

Item #	Description	Image
AXI4910	Flat Disposable Vitrectomy Lens Volk Lens, 10 per box	
AXI5012	Flat Disposable Lens Volk Lens, Self Stabilizing, 10 per box	
AXI5044	Magnifying Disposable Lens Volk Lens, 10 per box	
AXI5063	Wide Field Disposable Lens Volk Lens, 10 per box	
AXI5229	Bi-Concave Disposable Lens Volk Lens, 10 per box	
AXI5230	30 Degree Prism Disposable Lens Volk Lens, 10 per box	

CLEANERS & STERILIZERS

Item #	Description	Image
AXII397	Opti-Kleen Holding Tray The Opti-Kleen holding tray with lid is used to cradle the disposable cleaning system trays.	
AXII396	Opti-Kleen Blade Cleaning An efficient and safe method for cleaning tissue and other debris from the surfaces of diamond knife blades prior to sterilization. The Opti-Kleen blade cleaning system comes with twelve individual disposable trays per dispenser box. Each Tray contains three separate cleaning sections: a scrubbing section, and two rinse sections.	



1-800-979-2020 • 610-889-0200 • FAX 610-889-3233 • info@accutome.com • www.accutome.com

Total Solutions Provider for all of your ophthalmic needs.

ACCUTOME SURGICAL

Diamond Knives, Steel Knives, Sutures and Handheld Surgical Instruments.

ACCUTOME CLINICAL

Office Medications and Supplies.

ACCUTOME DIAGNOSTIC

A-Scans, B-Scans, Pachymeters, Tonometer and UBM.

ACCUTOME REPAIR CENTER

- Quick turnaround for most brands of Diamond Knives and Handheld Instruments.
- Diagnostic Equipment.

ORDERING

Call toll free 800) 979.2020 US and Canada
(610) 889.0200 International
+31 (0) 485.350300 Europe
Monday thru Friday 8:30AM - 8PM EST
Fax: 610.889.3233
Email: info@accutome.com
Web: www.accutome.com

SHIPPING

Ground - Via UPS Ground Service
Air - Via best method

Saturday - Orders must be placed before 3PM EST
Friday to ensure Saturday delivery.

Payment should be made by check, Bank Transfer, Visa, MasterCard or American Express.

CONTACT US



WATCH RESOURCES

youtube.com/c/accutome



LIKE US

facebook.com/pages/Accutome-Inc



TWEET US

twitter.com/accutome



FOLLOW US

linkedin.com/company/accutome-inc



GOOGLE+

plus.google.com/+Accutome/

Distributed by: