

Keeler Cryomatic MKII

Cryosurgical console

Instructions for use

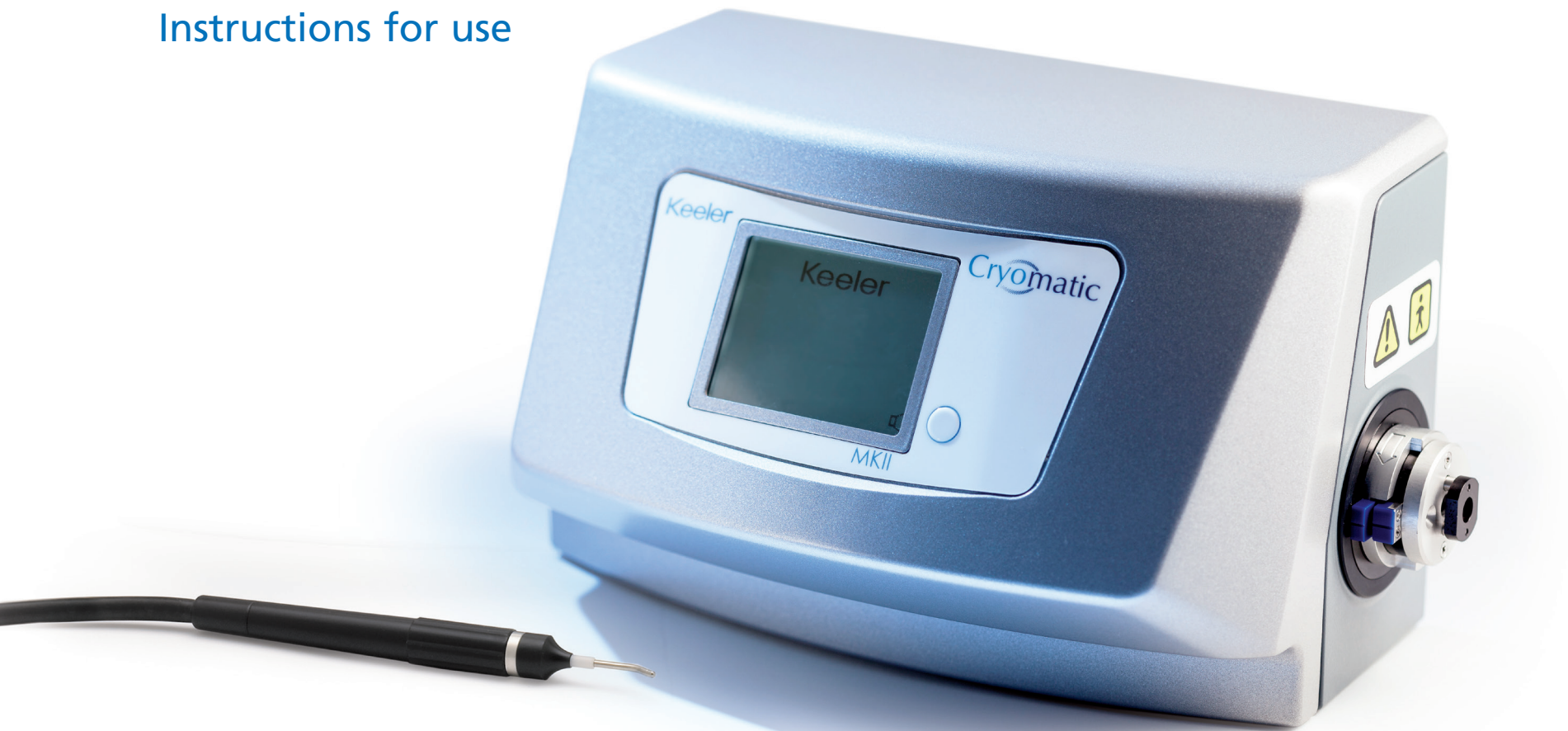

Keeler

Next ▶

Contents

	Page		Page
1. Copyright and trademarks	3	8. Cryo probes	19
2. Introduction		9. Cleaning and sterilization	20
• <i>About this manual</i>	4	• <i>Cleaning</i>	
• <i>About Cryomatic MKII</i>		• <i>Steam sterilization</i>	21
• <i>Product description</i>	5	• <i>Cleaning the console</i>	22
3. Symbols	6	10. Servicing and preventative maintenance	23
4. Safety		• <i>Scheduled maintenance</i>	
• <i>Device classification</i>		• <i>User maintenance</i>	
• <i>Warnings and cautions</i>	8	11. Troubleshooting guide	24
• <i>Safety considerations</i>	10	12. Specifications and electrical ratings	26
5. Controls, indicators and connections	11	• <i>Electrical specifications</i>	
6. Installation and commissioning	12	• <i>Pneumatic specifications</i>	
• <i>Preparing the Cryomatic MKII for use</i>		• <i>Transport, storage and operation</i>	
7. Operation		13. Annex I – EMC statement and guidelines	27
• <i>Initialisation</i>	15	14. Spare parts and accessories	31
• <i>Cryo probe connection</i>	16	15. Warranty	32
• <i>Freeze/Defrost cycles</i>		16. Contact and disposal information	33
• <i>Cryo probe disconnection</i>	17		
• <i>Mute Function</i>			
• <i>Fault conditions</i>			
• <i>End of use</i>	18		

Click on the headings above to go directly to that section.

Use the buttons on the right to navigate the document.

Clicking 'Home' from any page brings you back to this contents page.

1. Copyright and trademarks

The information contained within this manual must not be reproduced in whole or in part without the manufacturer's prior written approval.

As part of our policy for continued product development we reserve the right to make changes to specifications and other information contained in this document without prior notice.

Cryomatic MKII is a registered trademark of Keeler Ltd 2013.

Copyright © Keeler Limited 2013.

Published in the UK 2013.

Keeler

2. Introduction

Thank you for purchasing your Keeler Cryomatic MKII.

We have taken the greatest care in the design, development and manufacture of this product to ensure that you get many years of trouble free service. However, it is important that you read the descriptions, installation and operating instructions carefully prior to installing or using your new Cryomatic MKII.

About this Manual

This handbook forms the Instructions for Use for the Keeler Cryomatic MKII, a clinical instrument for cryogenic ophthalmic surgery.

It contains complete, step-by-step instructions for the Cryomatic MKII and is intended for use by trained medical personnel. This manual does not contain clinical instructions or any recommendations for medical applications. The use of the Cryomatic MKII in any surgical procedure must always be at the discretion of a licensed medical practitioner.

Intended use

The Keeler Cryomatic MKII System and probes are for use in ophthalmic surgery such as cryopexy for retinal detachment, cyclo destructive procedures in refractory glaucoma, extraction of fragments within the vitreous cavity, cataract extraction, cryo destruction of lash follicles for trichiasis and treatment of retinopathy of prematurity (ROP).

Once the Cryo probe has been correctly positioned the freeze control is activated and an ice ball is formed around the tip of the Cryo probe and the adjacent area.

Please read and follow these instructions carefully.

Keeler

2. Introduction

Product Description

The system comprises a control console and interchangeable Cryo probes which are connected to the console for use. The re-usable Cryo probe can be sterilized by autoclaving or other approved methods. The system requires mains electricity and Nitrous Oxide or Carbon Dioxide gas to function, this is the responsibility of the user.

Console

The Cryomatic MKII console is a self contained system. The console provides the connection point for the Cryo probe, footswitch, mains electricity, gas supply and scavenging system. Freeze cycles are controlled by the user operating the footswitch. When the footswitch is depressed the Cryo probe freezes and when the footswitch is released the Cryo probe defrosts. Routine functions, like purging the Cryo probe are performed automatically when the Cryo probe is connected to the system.

Cryo Probes

Disposable and reusable Cryo probes are connected to the Cryomatic MKII console via a simple quick release coupling. The system will not operate until this connection is correctly made. Each Cryo probe is a complete assembly and no attempt should be made to dismantle or separate the coupling from the probe.

When the footswitch is pressed, high pressure cryogen gas is circulated through the Cryo probe, rapid gas expansion in the probe tip causes freezing according to the Joule-Thompson principle. The freezing zone of the Cryo probe is limited so that the iceball propagates at the tip. When the footswitch is released, an active de-frost is caused by the equalisation of pressure on either side of the Joule-Thompson nozzle. The gas condenses releasing its latent heat causing a rapid de-frost.

The Cryo probe assembly is re-usable and as such is fully autoclaveable according to the procedures outlined in this manual.

Keeler

3. Symbols



Read user instructions for warnings, cautions and additional information



The CE mark on this product indicates it has been tested to and conforms with the provisions noted within the 93/42/EEC Medical Device Directive



Consult instructions for use



Manufacturer's name and address



This symbol on the product or on its packaging and instructions indicates that it was put on the market place after August 2005 and that this product shall not be treated as Household Waste



Type BF protections against shock



Mandatory action sign



High voltage



Trip hazard



Pressurized cylinder



Freeze hazard



Non-ionizing radiation

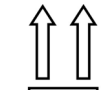

This way up



Keep dry



Fragile















Material suitable for recycling







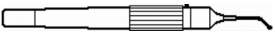

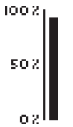
Audio active

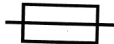
Keeler

3. Symbols

Screen Icons Used On The Equipment	
	Gas cylinder status. <i>This symbol contains an activity bar whenever the gas supply is being checked. It is solid when reporting cylinder pressure.</i>
	Ready Symbol. <i>Displayed whenever the freeze function can be activated via the footswitch.</i>
	Wait Symbol. <i>Animated icon that is displayed for the duration of the purge cycle.</i>
	Freezing symbol. <i>Displayed with the probe symbol while in freezing mode.</i>
	Run.
	Defrosting symbol. <i>Displayed with the probe symbol while in defrosting mode.</i>
	Audible sounder enabled during freezing mode.
	Audible sounder disabled during freezing mode.
	Fault Condition.
	Remove Probe. <i>This symbol will flash to inform the user that the probe needs to be removed.</i>
	Reusable probe.
	Disposable probe.
	Probe performance meter. <i>Displayed with the probe symbol while in freezing mode.</i>

Symbols used on the equipment			
<i>All symbols used are in accordance with BS EN60417-2:1999 (Graphical Symbols for use on Equipment).</i>			
	BF (Applied Part)		Fuse rating
	Attention, consult accompanying documents		Footswitch connection
	Dangerous voltages present inside the equipment		Exhaust connection
	AC voltage input		Gas inlet connection

4. Safety

Device classification

CE Regulation 93/42 EEC: IIb

FDA: II

Carefully read this Instruction Section before using your Keeler product. For your own safety and that of your customers observe all cautionary information provided in this section. The following information is intended to highlight potential safety hazards that can be associated with misuse, or damage.

Warnings and cautions



Warning



- **WARNING:** To avoid the risk of electric shock, this equipment must only be connected to a supply mains with protective earth
- Check your Cryomatic MKII for signs of transport / storage damage prior to use
- Do not use if the product is visibly damaged, and periodically inspect for signs of damage
- Do not use in the presence of flammable gases / liquids, or in an oxygen rich environment
- This product should not be immersed in fluids



Do not fit mains power adapter into a damaged mains outlet socket



Route power cords safely to eliminate risk of tripping or damage to equipment

- US Federal law restricts this device to sale by or order of a physician or practitioner



High pressure gases are present inside the unit. Maximum operating pressure 45 Bar / 650 PSI, maximum cylinder pressure 83 Bar / 1200 PSI

Observe the usual safety precautions associated with the use of medical gases, at all times. Copies of these guidelines will be available from the gas supplier.

Ensure the correct disposition of gas exhausted from the system so as to minimise the exposure to Nitrous Oxide or Carbon Dioxide. This is the responsibility of the user.



Ensure that sufficient gas is available in the cylinder prior to operation. **TEST BEFORE USE.** If in doubt ensure that a replacement cylinder is immediately available at the point of use.

Keeler

4. Safety



Caution

- Use only genuine Keeler approved parts and accessories or device safety and performance may be compromised
- The product has been designed to function safely when at an ambient temperature between +10°C and +35°C
- Keep out of the reach of children
- To prevent condensation from forming, allow instrument to come to room temperature before use
- For indoor use only (protect from moisture)
- Keep the console away from sources of liquids and do not spray with water
- This product is suitable for use with only Nitrous Oxide or Carbon Dioxide medical gases
- Only non-syphonic gas cylinders should be used with this device
- No modification of this equipment is allowed
- Care should be taken not to trap fingers in pinch points during gas bottle change
- Follow guidance on cleaning / routine maintenance to prevent personal injury / damage to equipment
- The mains plug is the means of isolating the device from the mains supply. Ensure the mains plug is accessible at all times



Switch off the electrical supply and disconnect from the mains electrical supply before cleaning and inspection

- Do not use hypercarbonate or phenolic based cleaning solutions or disinfectants containing cationic surfactants (e.g. Dettox) to clean the console
- Failure to carry out recommended routine maintenance as per these Instructions for Use may reduce the operational lifetime of the product
- There are no user serviceable parts inside. Contact authorised service representative for further information
- At product end of life dispose of in accordance with local environmental guidelines (WEEE)
- In the unlikely event that the probe fails to defrost, immediately switch off the console and apply saline solution to the probe
- Do not obstruct the vent holes on the disposable probe (located on the tube) and reusable probe, located as indicated below

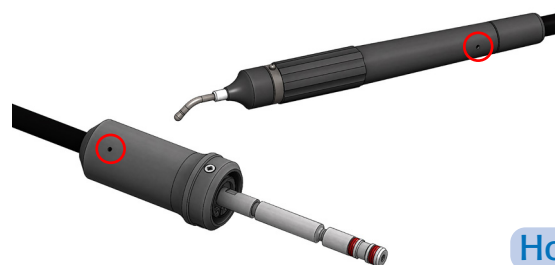

Keeler

4. Safety

Safety considerations

Before you connect system to the mains socket, carefully read and understand all the installation instructions in Section 6.

The system has been designed to comply with the following regulatory standards for Safety and Electromagnetic Compatibility:

- IEC60601-1, UL60601-1 & CAN/CSA-C22.2 No 601.1
- IEC60601-1-2

Although compliant with applicable EMC standards, this equipment may still be susceptible to excessive emissions and/or may interfere with other more sensitive material. This system should be installed and used following the EMC environment guidelines contained in section 13 of this manual.

This system should only be used in conjunction with the relevant accessories and mains leads as supplied by the manufacturer or distributor. Failure to do this may affect the EMC performance of the system i.e. increased emissions or reduced immunity. Relevant accessories are listed in the Spare Parts and Accessories section.

Ensure the equipment is positioned in such a way that it can be disconnected from the mains easily.



For your own safety and the safety of the equipment, always take the following precautions:

- Ensure that the system is inspected by properly trained personnel once per annum for performance and safety checks
- Inspect the Cryo probe hose and silicone 'O' rings for damage before every use. If there is any sign of damage return to the manufacturer for servicing prior to use
- Do not try to straighten a bent Cryo tip
- Do not try to re-shape a Cryo tip
- Ensure that the system is clean and dry prior to storage
- Keep this operator manual safe for future reference.

Keeler

5. Controls, indicators and connections

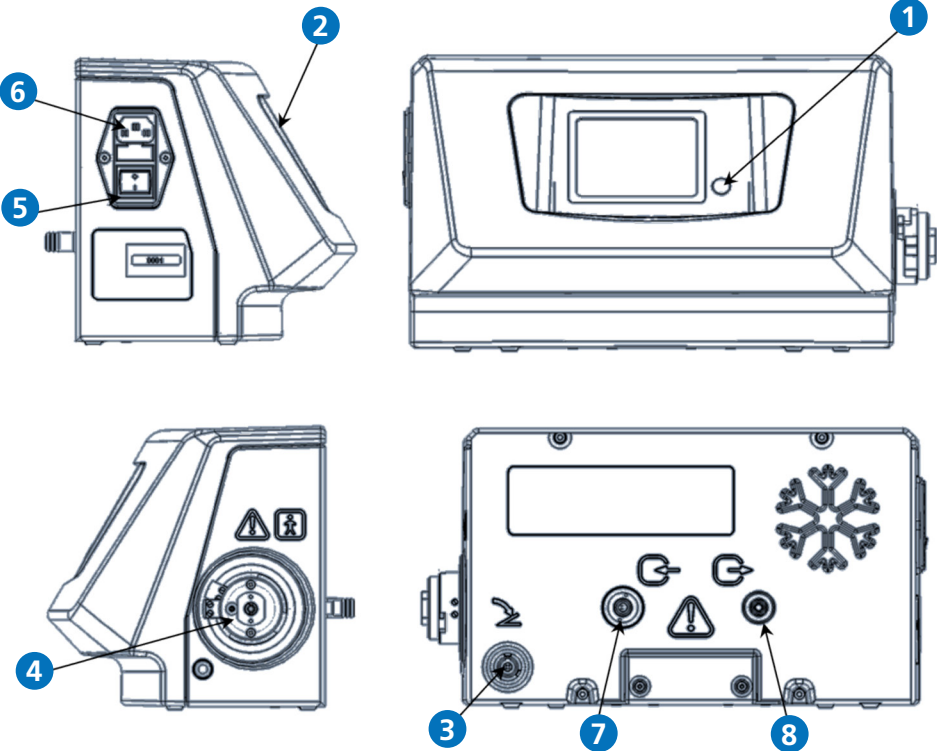

- 1 Run / Mute**
 Activates system:
 Reusable: Initiates purge cycle prior to use.
 Disposable: Ready for use.
 Mutes/un-mute audio during use.
- 2 Cryomatic MKII Display Screen**
 Graphical LCD used to provide system information to the user; such as probe information, gas cylinder status and freeze time.
- 3 Footswitch Connection**
 Connection point for footswitch plug.
- 4 Cryo Probe Interface**
 Connection point for probe.
- 5 Electrical Input**
 IEC connection for mains input lead.
- 6 On/Off Switch**
 On/off mains rocker switch.
- 7 High Pressure Gas Inlet**
 Connection point for cylinder hose.
- 8 Exhaust**
 For connection of vent hose.

6. Installation and commissioning

Preparing the Cryomatic MKII for use

The Cryomatic MKII consists of the following:

- Cryomatic MKII console
- Footswitch
- Mains cord
- High-pressure gas hose
- Exhaust hose
- Adjustable wrench
- Instructions for use
- 2 spare mains fuses
- Cryo probe(s) must be ordered separately

If any of these parts are missing, contact your distributor immediately.

Installing Exhaust Hose

Connect the exhaust hose provided from the gas exhaust connection of the console to a scavenging system or suitably ventilated area (see page 11).

It is the responsibility of the user to ensure the safe disposition of exhaust gases.



Connecting the Footswitch

Connect the footswitch to the appropriate connection point on the rear of the console noting the alignment of the orientation key (see page 11).

The footswitch can be disconnected for storage and to facilitate cleaning. Disconnection is achieved by pulling the collar of the footswitch connector.



Installing the High Pressure Gas Hose

Connect high-pressure hose to the inlet connector (7) at the rear of the Cryomatic MKII system using the adjustable wrench that has been provided. Ensure that the coupling is tightened adequately (see page 13).

Connecting/Changing Gas Cylinders

Gas cylinders must be stored upright, and for a minimum of eight hours at ambient room temperature prior to use.

Ensure that the gas cylinder is secured properly before use.

Use the following procedure for connecting or changing gas cylinders:

Keeler

6. Installation and commissioning

Connection of Cylinder

- 1 Secure gas cylinder correctly in the upright position.
- 2 Connect the high pressure hose to the cylinder using the relevant adaptor.
- 3 Open cylinder valve slowly (using the adjustable wrench provided).
- 4 Any noise of escaping gas indicates that the cylinder has not been connected correctly – turn off the gas valve and check connections.
- 5 Ensure the maximum cylinder pressure does not exceed 1200 PSI/83 Bar.

Keeler recommends fitting a regulator, set below 83bar, between the cylinder and the Cryomatic MKII console to prevent overpressure due to temperature variations in the cylinder.

Removal/Disconnection of Cylinders

- 1 Ensure that cylinder valve is closed.
- 2 Disconnect the adaptor from the cylinder.
- 3 Replace cylinder with a fresh one.

The cylinders must be medical grade vapour withdrawal types to ensure that liquid cryogen is not delivered to the system.

Cryogen gas cylinders used must meet national regulations and be in accordance with ISO/R 32 and NFPA 99 (USA).

Ensure there is enough gas in the cylinder prior to starting the procedure. The console cylinder symbol flashes to indicate empty when the gas supply pressure drops below **450 PSI/31 Bar** (3100 kPa) and the gas cylinder should be replaced at or before this point. After this the system will continue to function in the usual way, however freeze performance will be reduced.

Information regarding the correct storage and handling of gas cylinders should be obtained from the gas supplier.

The high pressure hose may remain pressurised after the system is disconnected from the electrical supply and the cylinder valve has been closed. Caution should be exercised when disconnecting the high pressure hose from the port at the rear of the console. This connection should be undone slowly in order that the high pressure hose is de-pressurised completely before it is removed.

Keeler

6. Installation and commissioning

Electrical Supply

The Cryomatic MKII system requires connection to a mains electrical supply for operation.



Only a hospital grade 3-conductor electrical power supply cable must be used.

For USA and Canada: Detachable power supply cord set, UL listed, type SJE, SJT or SJO, 3-conductor, not smaller than 18 AWG. Plug, cable and ground lead connection of the socket have to be in perfect condition.



At this stage the probe should NOT be connected.

- 1 Connect the system to a suitable mains supply using the mains cord that has been supplied.
- 2 Switch on power via the rocker switch at the side of the system.



- 3 The cylinder symbol is activated while the Cryomatic MKII system prepares itself and Mute symbol will displayed on the screen.

Keeler



7. Operation

These instructions cover day-to-day operation of the system. Other operations, such as maintenance and repair, should only be carried out by fully trained personnel who are employed by, or authorized by, the supplier.

Initialisation

Before using the Cryomatic MKII system, make sure it has been correctly installed in accordance with Section 6.

At this stage the probe must NOT be connected. If a probe has been connected a flash arrow will appear indicating that the probe must be removed.

-  1 Ensure that the equipment is switched on using the mains inlet rocker switch.
-  2 An activity bar within the Cylinder Symbol indicates that the gas supply is being checked.

If a warning is displayed, refer to troubleshooting in Section 11.

- 3 When the initialisation checks are complete verify that there is adequate cryogen gas supply - this is indicated by the Cylinder Symbol on the front panel display. The Cylinder Symbol will flash if the cylinder pressure drops below a viable level (450PSI).



Cylinder pressure good.



Cylinder at or below minimum pressure required to ensure safe and effective operation. Replace gas cylinder, or ensure that a replacement cylinder is immediately available at the point of use.

- 4 The equipment is now at REST. The Cryo Probe can now be connected.

The collar will move in a clockwise direction indicating that the probe is correctly locked. When the probe is properly connected the relevant Probe Symbol is displayed together with the Accept option.

Keeler

7. Operation

Cryo Probe Connection



Observe sterilization protocol before using a Cryo probe (see section 9). Allow Cryo probe to cool to room temperature after a sterilization.

 Before connecting the Cryo probe inspect it for signs of obvious damage.

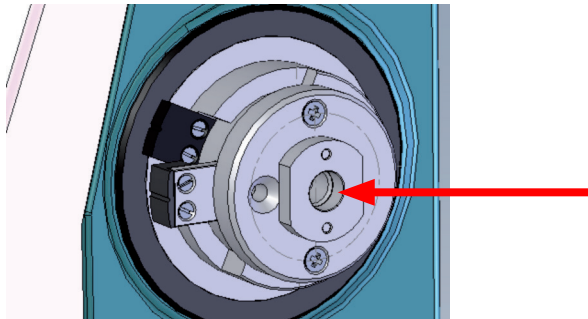
- 1 Remove sterilisation cap from the probe.



- 2 Connect the Cryo probe to the console by inserting it into the coupling and pushing against the spring operated collar until a positive click is heard. When the probe is properly connected the relevant Probe Symbol is displayed together with the Run option.

- 3 To proceed, the Run button must be pushed.
- 4 If a **reusable probe** has been connected, the system automatically initiates a purging cycle of 90 seconds.
 During the purge cycle an animated Wait Symbol is displayed alongside the Probe Symbol. Three short beeps signal that the purge cycle is complete.
- 5 The equipment is now ready for use as indicated by the timer and the Ready Symbol.

- 6 If a disposable probe has been connected, there is no purge cycle.

While the probe is purging all footswitch operations are disallowed to ensure that the Cryo probe has completed the minimum purge.

7. Operation



WARNING: Probe tip reaches extremely low temperature in use (between -20°C and -60°C depending on probe type used).

Freeze/Defrost Cycles

Freezing of the Cryo probe is controlled manually by the operator using the footswitch.

00:06



- 1 Press the footswitch down. Freezing starts immediately and the digital timer will increment.
- 2 An audible warning sounds every second during the freeze cycle and the Freezing Symbol is displayed.
- 3 In addition there is a graphical indication of probe performance.
- 4 De-frosting is achieved by releasing the footswitch. The timer will stop counting and the Defrosting Symbol is displayed.
- 5 Subsequent freeze cycles can be carried out by simply repeating steps 1-4 as soon as the Ready Symbol is displayed.



The freezing function is often accompanied by a characteristic 'pulsing' sound which indicates that the Cryomatic MKII is regulating the gas to the optimum pressure for the probe. The 'pulsing' may vary or cease completely depending on the pressure of gas in the cylinder.

If the probe performance drops below 100% permanently check the cylinder gas pressure or suspect a blocked probe.

Cryo Probe Disconnection



Do not disconnect the probe while the unit is under pressure (Footswitch activated)

- 1 Rotate the collar on the probe coupling (counter clockwise) until it aligns with the release button.
- 2 Press release button firmly whilst aligned with collar.

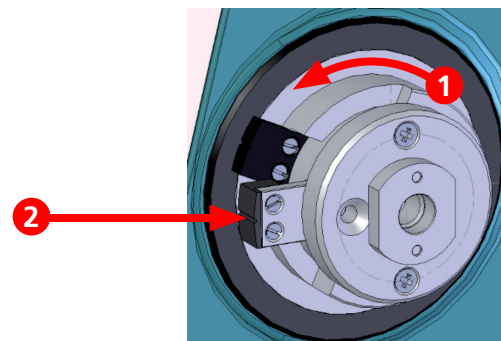

- 3 Refit the sterilisation cap to the probe.

The system shuts off the gas supply immediately the Cryo probe is disconnected. It is not recommended that the Cryo probe is disconnected during use.

Keeler

7. Operation

Mute Function

 The audible indicator is normally active during freeze and purge cycles as indicated on the LCD screen.

 It can be muted by pressing the key adjacent to the symbol. The symbol is changed accordingly. The indicator can be reactivated by pressing the key again (see Section 5 [1]).

Fault Conditions

 The Cryomatic MKII system has the ability to detect a range of system faults. In the unlikely event of a fault condition arising, the fault symbol icon will flash and a short error message will be displayed. Refer to section 11 for troubleshooting.

Contact distributor or manufacturer for assistance.



Caution

In the event of power interruption during use the device valves fail safely closed.



End of Use

Ensure that the following procedures are carried out at the end of the current usage:

- 1 Close the cylinder valve.
- 2 Switch off the electrical supply.
- 3 Ensure that the mains cord, footswitch and the Cryo probes are stored properly to avoid accidental damage.

8. Cryo probes

The following ranges of ophthalmic Cryo Probes may be used with the Cryomatic MKII.

Disposable Probe



Part No.	Description
2508-P-7022	Box of 10 Single Use Retinal Probes

Standard Probe Range



2509-P-8020	2.5mm Standard Retinal Probe
2509-P-8021	2.5mm Extended Retinal Probe

Special Probe Range



Part No.	Description
2509-P-8022	2.5mm Mid Reach Retinal Probe
2509-P-8023	Intra Vitreal Retinal Probe
2509-P-8024	1.5mm Curved Cataract Probe
2509-P-8025	3mm Glaucoma
2509-P-8026	4 x 10mm Collins Trichiasis Probe

9. Cleaning and sterilization



Device	
All reusable Cryo Probes supplied by Keeler Ltd. As part of the Keeler Cryomatic MKII ophthalmic cryosurgery system.	
Warnings and Precautions	
General	<p>Cryo Probes are precision instruments and should be handled with care at all times. It is import that the flexible hose does not become kinked during normal use, storage, transportation or reprocessing. If this does occur the probe must be returned to the manufacturer for repair.</p> <p>Ensure the sterilisation cap is fitted prior to sterilisation to avoid the ingress of moisture and contaminants which could result in a blocked probe.</p>
Limitations On Reprocessing	<p>Repeated processing has minimal effect on these instruments. End of life is normally determined by wear and damage due to use rather than processing.</p> <p>Cryo Probes are tolerant of alkaline cleaning agents when followed by acidic neutralisation and / or thorough rinsing.</p> <p>Gama irradiation or dry air sterilisation methods involving temperatures in excess of 139°C should not be used since they may damage the Cryo Probe.</p>
Instructions	
Before use, the complete Cryo Probe must be sterilized. Sterilization by steam autoclave has been validated.	
Point Of Use	No particular requirements although excess soiling can be removed with disposable cloth / paper wipe.
Containment and Transportation	<p>Care should be taken to ensure that the flexible hose of the Cryo-Tip probe is not coiled too tightly or kinked during reprocessing.</p> <p>Used instruments must be transported to the central supply in closed or covered containers to prevent unnecessary contamination risk. it is recommended that instruments are processed as soon as is reasonably practical following use.</p>
Preparation For Cleaning	Ensure sterilisation cap is fitted. Disassembly not required.
Cleaning and Disinfection: Automated	<p>Use equipment meeting relevant standards¹ and which uses an automated sequence equating to the following process as validated by the manufacturer as providing an acceptable level of cleanliness prior to steam sterilization:</p> <ul style="list-style-type: none"> • Pre-Rinse/Wash: water for 4 minutes at 40°C • Detergent Wash: hot water using (detergent specified by the washer/disinfector manufacturer) for 4 minutes at 85°C (185°F) • Thermal Rinse: hot purified water 80-85°C (176-185°F) for 10 minutes OR 90-93°C (194-199°F) for 1 minute • Hot Air Dry ¹ <i>HTM2030 and BS EN ISO 15883, ANSI/AAMI ST79, or equivalent</i>
Cleaning: Manual	Not recommended – do not carry out manual cleaning.

9. Cleaning and sterilization



Instructions continued																			
Drying	Hot Air Dry																		
Maintenance	Check for obvious signs of damage – return to manufacturer if any damage is noted.																		
Inspection & Function Testing	Visually inspect for damage and wear. Check probe tips for signs of bending, distortion or other damage. Connect Cryo Probe to 'Cryomatic MKII' console to check correct and smooth function of probe quick release coupling.																		
Packaging	Paper autoclave bag meeting ISO 11607 requirements with chemical indicators meeting ISO 11140-1, or follow guidance provided in ANSI/AAMI ST79 - Refer to the product-specific instruction manual for compatibility with steam sterilisation.																		
Sterilisation	<p>Cryo Probe must be cleaned prior to sterilisation. Thorough cleaning removes both micro-organisms and organic material. Failure to remove organic material decreases effectiveness of the sterilisation procedure. After cleaning, make sure that the instrument is carefully dried.</p> <p>Place the instruments in appropriate instrument trays or pouches. Wrap or seal them adequately. Do not seal the instruments in close contact with each other as this might impair the sterilisation effect.</p> <p>Never rinse the instruments with cold water for cooling. Be careful when unloading the autoclave, the contents may be hot.</p> <p>Make sure that the sterile package of the instruments is not damaged. If the package has been perforated, if the sealing has been opened, if the packaging is wet or if the packaging is damaged in any other way, repackage and then re-sterilise the instruments.</p> <p>Disinfection is only acceptable as a precursor to full sterilisation for reusable surgical instruments. See Table 1 for recommended sterilisation parameters using equipment meeting relevant standards. These parameters have been validated by the manufacturer as providing effective sterilization, and are in accordance with the typical cycle parameters in ANSI/AAMI ST79 Table 5.</p> <p>Steriliser manufacturer recommendations should always be followed. When sterilising multiple probes in one sterilisation cycle, ensure that the manufacturer's maximum load is not exceeded.</p> <table border="1"> <thead> <tr> <th colspan="5">Table 1</th> </tr> <tr> <th>Sterilizer type</th> <th>Temperature</th> <th>Pressure</th> <th>Exposure time</th> <th>Drying time</th> </tr> </thead> <tbody> <tr> <td>Pre-vacuum (porous load)</td> <td>134 – 137 °C (273 – 279 °F)</td> <td>-</td> <td>3 minutes</td> <td>20 minutes</td> </tr> </tbody> </table> <p>NB: For users concerned with reducing the infectivity of prions, a pre-vacuum cycle of 134 – 137 °C (273 – 279 °F) for 18 minutes with the same drying time as above has also been validated by the manufacturer</p> <p>It is the responsibility of the user to validate any sterilisation process that deviates from these recommendations.</p>				Table 1					Sterilizer type	Temperature	Pressure	Exposure time	Drying time	Pre-vacuum (porous load)	134 – 137 °C (273 – 279 °F)	-	3 minutes	20 minutes
Table 1																			
Sterilizer type	Temperature	Pressure	Exposure time	Drying time															
Pre-vacuum (porous load)	134 – 137 °C (273 – 279 °F)	-	3 minutes	20 minutes															

9. Cleaning and sterilization



Instructions continued

Storage

As the product's transport packaging is not designed for storage, do not store the product in the transport packaging. Use instrument tray systems for storage. Cryo probes should be coiled loosely during storage.

Store the sterile, Cryo probes in a clean and dry condition at room temperature

- Do not expose the equipment to direct sun light.
- Do not expose the equipment to sources of X-ray radiation.
- Do not store the equipment in a location where liquids may splash.
- Do not store the equipment under environmental conditions such as:
 - high atmospheric pressure
 - high or low temperatures
 - high or low humidity
 - direct ventilation
 - direct sunlight
 - dust
 - salty or sulphurous air
- Do not store the equipment where there is a risk of flammable gases.

The storage life of sterilised instruments depends on the type of packaging and the storage conditions. Refer to national and local laws and guidelines.

Cleaning the Console

The Cryomatic MKII console can be cleaned using a disposable cloth dampened with warm water with a mild detergent. Do not use abrasive compounds or pads. The user should avoid getting electrical parts wet during the cleaning process.



Warning:



Switch off the electrical supply to the console and disconnect the power cord from the mains supply before cleaning and inspection.

Keeler

10. Servicing and preventative maintenance

Scheduled Maintenance

The Cryomatic MKII console and probes should be inspected annually by Keeler trained personnel. This service will include performance checks, cleaning or replacement of inlet filters and safety checks on pneumatic couplings.

User Maintenance - Console

 There are no user serviceable parts in the Cryomatic MKII console, operator maintenance is restricted to cleaning the console surface.

User Maintenance - Reusable probes

- a Cleaning the Cryo probe tip.
- b Inspecting the Cryo probes for signs of damage before every use.
- c Damaged or missing 'O' ring seal should be replaced before sterilisation and use.



'O' ring should be fitted as shown

 Only Keeler specified parts should be used. See spares Section 14.

- d Inspecting the footswitch and cord for signs of damage before each use.
- e Inspecting the mains cord for signs of damage before each use.
- f Inspecting the high pressure hose and exhaust hose for signs of damage before each use.

 All repairs should be carried out only by Keeler trained personnel or their representatives.

Keeler will make available on request circuit diagrams, component part lists, descriptions, calibration instructions, or other information that will assist SERVICE PERSONNEL to repair those parts of ME EQUIPMENT that are designated as repairable by SERVICE PERSONNEL.

 Potentially dangerous voltages are present inside the equipment – under no circumstances should the covers be removed.

Keeler

11. Troubleshooting guide

The following table provides a troubleshooting guide for the Cryomatic MKII system in the event of minor problems. If the problem is not cleared then the supplier must be contacted for further assistance.

In the unlikely event that the probe fails to defrost, immediately switch off the console and apply saline solution to the probe.

Problem	Possible cause	Corrective action
Front panel blank - equipment appears dead.	Mains fuse blown.	Disconnect equipment from the mains supply and replace with fuses of the correct rating.
Probe coupling will not connect correctly.	Probe is still too hot after a sterilisation procedure (this may cause expansion of some coupling components).	Allow probe to cool to room temperature before trying to connect it.
Probe does not freeze at all.	Insufficient gas supply or cylinder valves not opened properly - cylinder symbol on front panel will flash empty.	Replace empty gas cylinder with a full one. Ensure that cylinder valve is opened correctly (see Section 6).
	Footswitch may have become disconnected.	Reconnect footswitch to console. If fault does not clear contact supplier for repair.
Reusable probe freezes but performance is poor.	Possible partial blockage in the probe (possibly cause by excess moisture after sterilization procedure). Probe may appear to begin to freeze but then blocks or performs poorly. Check front panel for associated fault code.	Ensure that correct sterilization procedures are followed, including a drying cycle (in sterilizer or drying oven). Disconnect and reconnect probe to force another purging cycle. If this fails then probe should be allowed to dry completely before use.
Probe freezes initially but then performance is reduced or probe does not freeze.	Blocked probe. Check front panel for associated fault code.	Release footswitch. Allow console to back-flush the probe before attempting another freeze.
	Gas supply has run out. Check cylinder symbol on front panel.	Replace gas cylinder. Ensure that cylinder valve is opened correctly. If fault does not clear contact supplier for repair.
	Exhaust hose is blocked or occluded.	Check exhaust hose for blockages or occlusions and replace if necessary.
Probe freezes correctly but Cryomatic delivery system is not pumping.	Cylinder pressure has dropped due to usage, but performance is still above the acceptable level.	Check cylinder symbol on the front panel to assure adequate gas supply pressure.
Auto defrost takes longer than usual.	Possible leaking internal hose connectors.	Return the console and probe for repair.
	Possible fault in console.	
Gas leak evident from around probe coupling connection.	Inspect probe for damaged O ring seals.	Return probe for replacement of seals.

*gas cylinders are deemed to be empty when the internal pressure is less than 350PSI / 24Bar (2415kPa)

11. Troubleshooting guide

The following table provides a troubleshooting guide for the Cryomatic MKII system error messages.

Error message	Possible cause	Corrective action
F-01 Gas Check Fault	Faulty valves and/or pressure sensors.	Contact distributor or manufacturer for assistance.
F-02 P2 Error	Pressure sensor error.	Contact distributor or manufacturer for assistance.
F-03 P3 Error	Pressure sensor error.	Contact distributor or manufacturer for assistance.
F-04 Probe Blocked	Partial or complete probe blockage.	Re-purge the probe. Use an alternative probe. Contact distributor or manufacturer for assistance.
F-05 V1 Error	Solenoid valve error.	Contact distributor or manufacturer for assistance.
F-06 V2 Error	Solenoid valve error.	Contact distributor or manufacturer for assistance.
F-07 V3 Error	Solenoid valve error.	Contact distributor or manufacturer for assistance.
F-008 Over Pressure	Cylinder pressure too high.	Contact distributor or manufacturer for assistance. Check cylinder pressure does not exceed recommended maximum pressure (83bar). Keeler recommends fitting a pressure regulator if cylinder pressure cannot be maintained below the maximum.
F-09 V1 Error	Solenoid valve leaking.	Contact distributor or manufacturer for assistance.

12. Specifications and electrical ratings

Cryo System	
Gas Specification	Medical grade Nitrous Oxide (N ₂ O) or Medical grade Carbon dioxide (CO ₂) in Non-syphonic cylinders
Operating range	3100-4480 kPa (450-650PSI/ 31-45 Bar)
Maximum Cylinder Pressure	8275 kPa (1200PSI/83Bar)

Electrical Ratings	
Input Voltage Range	100-240Vac (50/60Hz)
Power Rating	35-50VA
Fuses	2 x T2AH 250V

Dimensions	
Width	350mm (14")
Depth	200mm (8")
Height	190mm (7.5")
Weight	4.5kg (10lbs)

Classification and Safety Standards	
Complies with	EN60601-1, UL60601-1& CAN/CSA-C22.2 No 601.1
Equipment Classification	Class 1, type BF (Applied Part)
Mode of operation	Continuous
Protection against ingress	Console IP20 Footswitch IP66, IP67

Transport, storage and operating conditions			
	Transport	Storage	Operation
Temperature range	-40°C to +70°C	-10°C to +55°C	+10°C to +35°C
Relative humidity	10% to 95%	10% to 95%	30% to 90%
Atmospheric pressure	500hPa to 1060hPa	700hPa to 1060hPa	800hPa to 1060hPa

Keeler

13. Annex I – EMC statement and guidelines

Guidance and manufacturer's declaration – electromagnetic emissions		
The Cryomatic is intended for use in the electromagnetic environment specified below. The customer or user of the Cryomatic should assure that it is used in such an environment.		
Emissions test	Compliance	Electromagnetic environment - guidance
RF emissions CISPR 11	Group 1	The Cryomatic System uses RF energy only for its internal function. Therefore, its RF emissions are very low and are not likely to cause any interference in nearby electronic equipment. The Cryomatic System is suitable for use in all establishments, including domestic establishments and those directly connected to the public low-voltage power supply network that supplies buildings used for domestic purposes.
RF emissions CISPR 11	Class A	
Harmonic emissions IEC 61000-3-2	Class A	
Voltage fluctuations / flicker emissions IEC 61000-3-3	Complies	

13. Annex I – EMC statement and guidelines

Guidance and manufacturer's declaration – electromagnetic immunity			
The Cryomatic is intended for use in the electromagnetic environment specified below. The customer or the user should assure that it is used in such an environment.			
Immunity test	IEC 60601 Test level	Compliance level	Electromagnetic environment - guidance
Electrostatic discharge (ESD). IEC 61000-4-2	± 8 kV contact ± 15 kV air	± 8 kV contact ± 15 kV air	Floors should be wood, concrete or ceramic tile. If floors are covered with synthetic material, the relative humidity should be at least 30%.
Electrical fast transient/burst. IEC 61000-4-4	± 2 kV for power supply lines ± 1 kV for input/output lines	± 2 kV for power supply lines ± 1 kV for input/output lines	Mains power quality should be that of a typical commercial or hospital environment.
Surge. IEC 61000-4-5	± 1 kV line(s) to line(s) ± 2 kV line(s) to earth	± 1 kV line(s) to line(s) N/A	Mains power quality should be that of a typical commercial or hospital environment.
Voltage dips, short interruptions and voltage variations on power supply input lines. IEC 61000-4-11	$U_T = 0\%$ 0.5 cycle (0,45,90,135,180,225,270,315°) $U_T = 0\%$; 1 cycle $U_T = 70\%$; 25/30 cycles (@ 0°) $U_T = 0\%$; 250/300 cycle	$U_T = 0\%$ 0.5 cycle (0,45,90,135,180,225,270,315°) $U_T = 0\%$; 1 cycle $U_T = 70\%$; 25/30 cycles (@ 0°) $U_T = 0\%$; 250/300 cycle	Mains power quality should be that of a typical commercial or hospital environment. If the user of the Cryomatic requires continued operation during power mains interruptions, it is recommended that the instrument be powered from an uninterruptible power supply or battery.
Power frequency (50/60 Hz) magnetic field. IEC 61000-4-8	30 A/m	30 A/m	Power frequency magnetic fields should be at levels characteristic of a typical location in a typical commercial or hospital environment.

Note U_T is the a.c. mains voltage prior to application of the test level.

13. Annex I – EMC statement and guidelines

Guidance and manufacturer's declaration – electromagnetic immunity			
The Cryomatic is intended for use in the electromagnetic environment specified below. The customer or user should assure that it is used in such an environment.			
Immunity test	IEC 60601 Test level	Compliance level	Electromagnetic environment - guidance
Conducted RF IEC 61000-4-6	6 Vrms 150 kHz to 80 MHz	6 Vrms	<p>Portable and mobile RF communications equipment should be used no closer to any part of the Cryomatic, including cables, than the recommended separation distances calculated from the equation applicable to the frequency of the transmitter.</p> <p>Recommended separation distance $d = 1.2 \sqrt{p}$</p> <p>$d = 1.2 \sqrt{p}$ 80MHz to 800 MHz $d = 2.3 \sqrt{p}$ 800MHz to 2.7GHz</p> <p>Where p is the maximum output power rating of the transmitter in watts (W) according to the transmitter manufacturer and d is the recommended separation distance in metres(m).</p> <p>Field strengths from fixed RF transmitters, as determined by an electromagnetic site survey^a, should be less than the compliance level in each frequency range.^b</p> <p>Interference may occur in the vicinity of equipment marked with the following symbol: </p>
Radiated RF IEC 61000-4-3	10 V/m 80MHz to 2.7GHz	10 V/m	

Note 1 At 80MHz and 800MHz, the higher frequency range applies.

Note 2 These guidelines may not apply in all situations. Electromagnetic propagation is affected by absorption and reflection from structures, objects and people.

- a Field strengths from fixed transmitters, such as base stations (cellular/cordless) telephones and land mobile radios, amateur radio, AM and FM radio broadcast and TV broadcast cannot be predicted theoretically with accuracy. To assess the electromagnetic environment due to fixed RF transmitters, an electromagnetic site survey should be considered. If the measured field strength in the location in which the Cryomatic is used exceeds the applicable RF compliance level above, the Cryomatic should be observed to verify normal operation. If abnormal performance is observed, additional measures may be necessary, such as re-orientating or relocating the Cryomatic.
- b Over the frequency range 150kHz to 80 MHz, field strengths should be less than 10 V/m.

13. Annex I – EMC statement and guidelines

Recommended separation distances between portable and mobile RF communications equipment and the Cryomatic

The Cryomatic is intended for the use in an electromagnetic environment in which radiated RF disturbances are controlled. The customer or the user of the Cryomatic can help prevent electromagnetic interference by maintaining a minimum distance between portable and mobile RF communications equipment (transmitters) and the Cryomatic as recommended below, according to the maximum output power of the communications equipment.

Rated maximum output power of transmitter W	Separation distance according to frequency of transmitter m		
	150 kHz to 80MHz $d = 1.2\sqrt{p}$	80MHz to 800MHz $d = 1.2\sqrt{p}$	800MHz to 2.7GHz $d = 2.3\sqrt{p}$
0.01	0.12	0.12	0.23
0.1	0.38	0.38	0.73
1	1.2	1.2	2.3
10	3.8	3.8	7.3
100	12	12	23

For transmitters rated at a maximum output power not listed above, the recommended separation distance d in metres (m) can be estimated using the equation applicable to the frequency of the transmitter, where p is the maximum output power rating of the transmitter in watts (W) according to the transmitter manufacturer.

Note 1 At 80MHz and 800MHz, the higher frequency range applies.

Note 2 These guide lines may not apply in all situations. Electromagnetic propagation is affected by absorption and reflection from structures, objects and people.

The Cryomatic should not be used adjacent to or stacked with any other equipment. If this configuration is required, then normal operation of the Cryomatic should be verified in this setting.

14. Spare parts and accessories

The following accessories are supplied with the device:

Part Number	Description
EP59-11410	Instructions For Use
MIS094	Spare mains fuse (x2)
MIS100	Mains cord (UK)
MIS103	Adjustable wrench
2509-P-6000	Mains cord (Japan)
2509-P-8010	Exhaust hose
2509-P-8013	Footswitch assembly
2509-P-8014	High-pressure gas hose (2m)

The following additional accessories are available from the distributor (only use appropriately approved gas cylinder connectors/adapters for country of use):

Part Number	Description
2508-P-7015	Pin index yoke (E Size - Carbon Dioxide)
2508-P-7016	Cylinder Adaptor CO ₂ Size VF
2508-P-7017	Pin index yoke (E Size - Nitrous Oxide)
2508-P-7018	Cylinder Adaptor N ₂ O Size VF
2509-P-8009	Cylinder Adaptor N ₂ O (US – CGA326)
2509-P-8011	High-pressure gas hose (1m)
2509-P-8015	Probe sterilising box
MCU222W	Adaptors Washer (Cylinder Adaptor CO ₂ Size VF)

15. Warranty

The Cryomatic MKII and its components are covered by warranty that they meet their performance standards and are free from any defects in materials or workmanship. Within 24 months from delivery by Keeler, the manufacturer shall at no charge to the customer, upon written notice from the customer, repair or replace any components which are defective in material or workmanship.

The customer agrees that it shall have no remedy in the event of any breach of the foregoing warranty other than as provided above. This warranty is exclusive and in lieu of all other warranties, expressed or implied, and all implied warranties of merchantability or fitness for a particular purpose are expressly disclaimed.

The obligations of the manufacturer as set forth in this warranty are expressly conditional upon the following:-



(i) No alterations or repairs of any malfunction of the system shall be made to the system except by the manufacturer or his authorized representative, without the prior written approval of the manufacturer or his authorized representative (and in no case will the manufacturer assume responsibility for repairs or alterations made by those other than the manufacturer or his authorized representative).

And

(ii) The customer shall give notice to the manufacturer or their authorized representative of any malfunction of the system and shall not use the system in any surgical operation after they are aware of any malfunction.

(iii) The customer complies with manufacturer's recommended Preventative Maintenance (see Section 10) and can provide proof of such action.

Keeler

16. Contact, packaging and disposal information

Manufacturer

Keeler Limited
Clewer Hill Road
Windsor
Berkshire
SL4 4AA

Freephone 0800 521251
Tel +44 (0) 1753 857177
Fax +44 (0) 1753 827145

USA Sales Office

Keeler Instruments Inc
3222 Phoenixville Pike
Building #50
Malvern, PA 19355
USA

Toll Free 1 800 523 5620
Tel 1 610 353 4350
Fax 1 610 353 7814

India Office

Keeler India
Halmer India Pvt. Ltd.
B1-401, Boomerang, Chandivali
Andheri (East) Mumbai - 400072
India

Tel +91 (22) 6708 0405
Fax +91 (99303) 11090

China Office

Keeler China
1012B
KunTai International Mansion
12B ChaoWai St.
Chao Yang District
Beijing, 10020
China

Tel +86 (10) 51261868
Fax +86 (10) 58790155

Disposal of old electrical and electrical equipment

(Applicable in the European Union and other European Countries with separate Collection Systems).



This symbol on the Product or on its Packaging and instructions indicates it was put on the market place after August 2005 and this product shall not be treated as Household Waste.

To reduce the environmental impact of WEEE (Waste Electrical Electronic Equipment) and minimise the volume of WEEE entering landfills we encourage at product end of life that this Equipment is recycled and reused.

If you need more information on the collection, reuse and recycling then please contact B2B compliance on 01691 676124 (+44 1691 676124). (UK only).

EP59-11410-art-15

Keeler